



**“I’M INTERESTED IN
CREATING ELEMENTS FOR
EVERYDAY LIFE THAT ARE
EXCITING AND UPLIFTING
TO LIVE WITH.
EXPLORE AND USE
ACCESSORIES TO RE-INVENT
YOUR SPACE.”**

- TORD BOONTJE

NAME	TORD BOONTJE
BORN	ENSCHEDÉ (NL), 1968
EDUCATION	EINDHOVEN DESIGN ACADEMY, ROYAL COLLEGE OF ART, LONDON
WEBSITE	TORDBOONTJE.COM
CLIENTS	SWAROVSKI, MOROSO, PERRIER-JOUËT, HEWLETT PACKARD, , FORMANI, AND MANY MORE
DESIGN AWARDS	RED DOT DESIGN AWARD, WALLPAPER* DESIGN AWARDS, ELLE DÉCOR DESIGN AWARD, IF PRODUCT DESIGN AWARD, DUTCH DESIGNER OF THE YEAR
LIKES	LOBSTERS AND ELECTRONIC MUSIC
COLLECTION FORMANI	FOLD

FOLD
BY
TORD
BOONTJE



reddot design award
winner

FOLD BY TORD BOONTJE

INHOUDSOPGAVE | CONTENTS



FORMANI STORIES

STORY GENK, BELGIË | STORY GENK, BELGIUM 346

DEURBESLAG | DOOR FITTINGS 356

DEURKRUKKEN | LEVER HANDLES 356

ACCESSOIRES DEURKRUKKEN | LEVER HANDLE ACCESSORIES 356

RAAMBESLAG | WINDOW FITTINGS 357

DRAAIKIEPBESLAG | TILT AND TURN WINDOW HANDLES 357

KRUKESPAGNOLETTEN | ESPAGNOLETTE BOLTS 357

VOORDEURBESLAG | FRONT DOOR FITTINGS 358

VOORDEURKNOPPEN | FRONT DOOR KNOBS 358

GREPEN | PULL HANDLES 358

VEILIGHEIDSCILINDERROZETTEN | SECURITY ESCUTCHEONS 358

BELDRUKKERS | BELL PUSHES 358

ACCESSOIRES | ACCESSORIES 359

MEUBELGREPEN | CABINET HANDLES 359

MEUBELKNOPPEN | CABINET KNOBS 359

HEFSCHUIFDEURBESLAG | SLIDING DOOR HANDLES 359



BELGIUM GENK

LOCATION: GENK, BELGIUM
OBJECT: JEPUN TRADITIONAL SPA
PHOTOGRAPHY: TYCHO MERIJN ROEST



FOLD BY TORD BOONTJE
TB100 LEVER HANDLE SATIN STAINLESS STEEL



FORMANI®
FOLD BY TORD BOONTJE



EASTERN DESIGN

Jepun Traditional Spa in Genk, nabij het Nederlandse Maastricht, is een luxe saunacomplex waar men in privésetting geniet van oosterse wellness. Deze privésauna mag zich het meest luxe wellnessconcept van België noemen.

Jepun Traditional Spa in Genk, near the Dutch city Maastricht, is a luxury spa where you can enjoy Far Eastern wellness in a private setting. This private sauna is the most luxury wellness concept to be found in Belgium.



FOLD BY TORD BOONTJE
TB500 PULL HANDLE SATIN STAINLESS STEEL



RED DOT DESIGN AWARD

De hardware uit de Fold-serie sluit niet alleen aan bij de sfeer van de spa in Genk, maar is alom geprezen. De Fold-deurkruk is zelfs bekroond met de Red Dot Design Award. Het is een van 's werelds meest innovatieve deurkrukken ooit. Nooit eerder werd een deurkruk uit één deel gefabriceerd. Een deurkruk die bovendien het slot geruisloos bedient.

The fittings from the Fold series do not only match the character of the spa in Genk, but have been generally praised. The Fold door handle was even awarded the Red Dot Design Award and is one of the most innovative door handles that the world has seen. Never before was a door handle fashioned from one single part. This door handle also controls the lock without making a sound.



FOLD BY TORD BOONTJE

TB100 LEVER HANDLE SATIN STAINLESS STEEL

TBWC50 PRIVACY SET SATIN STAINLESS STEEL



FOLD BY TORD BOONTJE
TB20M CABINET KNOB SATIN STAINLESS STEEL

IN BALANCE

De doorware uit de Fold-serie lijkt te zweven. Het sierlijke ontwerp is in balans met de onderliggende, innovatieve kracht. Een balans die aansluit bij de aandacht voor lichaam en geest zoals men die vindt in de spa in Genk.

The door fittings from the Fold series appear to be floating. The ornamental design is balanced by the underlying, innovative force. This balance blends with the focus on body and mind found at the spa in Genk.







FOLD BY TORD BOONTJE
TB20/160 CABINET HANDLE SATIN STAINLESS STEEL

FOLD BY TORD BOONTJE

DEURBESLAG | DOOR FITTINGS

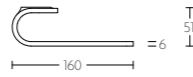
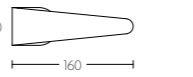
TB100

massieve deurkruk geveerd op verborgen rozet | solid sprung lever handle on concealed rose

TB100 TBN50 TBY50 TBB50 TBWC50





reddot design award winner

mat roestvast staal
satin stainless steel

TBN50

sleutelplaatje | key escutcheon





TBN50

mat roestvast staal
satin stainless steel

TBY50

cilinderplaatje | profile cylinder escutcheon





TBY50

mat roestvast staal
satin stainless steel

TBB50

blind plaatje | blank escutcheon

TBB50

mat roestvast staal
satin stainless steel

TBWC50

toiletgarnituur | turn and release set



TBWC50

mat roestvast staal
satin stainless steel

FOLD BY TORD BOONTJE

DEURBESLAG & RAAMBESLAG | DOOR FITTINGS & WINDOW FITTINGS

TBWC50B

toiletgarnituur | turn and release set





TBWC50B

mat roestvast staal
satin stainless steel

TB110-DK-O

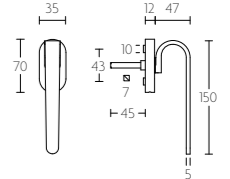
draaikiepgarnituur niet afsluitbaar | non-locking tilt and turn window handle





TB110-DK-O

mat roestvast staal
satin stainless steel

TB110-DKLOCK-O

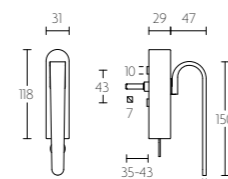
draaikiepgarnituur afsluitbaar | locking tilt and turn window handle

TB110-DKLOCK-O

mat roestvast staal
satin stainless steel

KO-TB110

krukespagnolet inclusief vier geleiders, twee eindstukjes en twee stangen
standaard geschikt tot 2900mm

espagnolette bolt with top and bottom receiver plate, two rods and four rod guides
standard to suit 2900mm

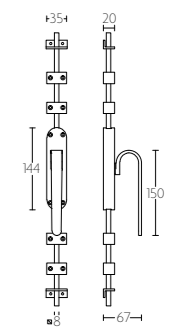
KO-TB110

mat roestvast staal
satin stainless steel

E-LOCK8

slot ten behoeve van espagnoletstang 8mm
lock for espagnolette rod 8mm



E-LOCK8

mat roestvast staal
satin stainless steel

FOLD BY TORD BOONTJE

VOORDEURBESLAG | FRONT DOOR FITTINGS

TB200V | massieve vaste voordeurknop | solid fixed front door knob

mat roestvast staal
satin stainless steel

TB500 | massieve greep tbv houten, glazen of aluminium deuren doorgaande, niet-doorgaande of paarsgewijze bevestiging | solid pull handle for timber, glass or aluminium doors bolt through, concealed or back to back fixings

mat roestvast staal
satin stainless steel

TB501 | massieve greep tbv houten, glazen of aluminium deuren doorgaande, niet-doorgaande of paarsgewijze bevestiging | solid pull handle for timber, glass or aluminium doors bolt through, concealed or back to back fixings

mat roestvast staal
satin stainless steel

BVEIL | massieve veiligheidscilinderrozet | solid security escutcheons

mat roestvast staal
satin stainless steel

BVEIL-KT | massieve veiligheidscilinderrozet met kerntrekbeveiliging | solid security escutcheons with cylinder protection cover

mat roestvast staal
satin stainless steel

TB50 | beldrukker met roestvast stalen drukkertje | bell push with stainless steel bell button

mat roestvast staal
satin stainless steel

FOLD BY TORD BOONTJE

ACCESSOIRES | ACCESSORIES

TB20/160 | massieve meubelgreep | solid cabinet handle

mat roestvast staal
satin stainless steel

TB20/320 | massieve meubelgreep | solid cabinet handle

mat roestvast staal
satin stainless steel

TB20M | massieve meubelknop | solid cabinet knob

mat roestvast staal
satin stainless steel

TB230 | massieve set hefschuifdeurbeslag inclusief schuifdeurkom voor buitenzijde | single solid internal lift-up sliding door handle with external flush pull

mat roestvast staal
satin stainless steel

* blind of PC69
* blind of Y69

TIMELESS

INSPIRED BY BAUHAUS

Timeless. De naam verraaft al dat het gaat om een assortiment dat de tand des tijds doorstaan heeft. De serie bestaat stuk voor stuk uit producten van weleer die door FORMANI® nieuw leven zijn ingeblazen, al dan niet gecombineerd met een stukje hedendaagse techniek en functionaliteit. Een grote inspiratiebron voor de serie vormt het BAUHAUS instituut (opgericht door Walter Gropius in Weimar, 1 april 1919), één van Europa's grootste kunststromingen die ontstaan is tijdens het Interbellum.

De Bauhaus filosofie was kortgezegd eenvoudig en functionaliteit. De details werden weggelaten en de essentie van een ontwerp werd zichtbaar in de schoonheid van eenvoud. 'Less is more', de wereldberoemde quote, is dan ook niet toevallig afkomstig uit de Bauhaus-periode. Ondanks dat het Bauhaus instituut slechts veertien jaar bestond, is het een begrip dat tot op de dag van vandaag invloed uitoefent op design en architectuur.

Ontwerpen van grote Bauhaus namen als Walter Gropius en Wilhelm Wagenfelt dienen als inspiratiebron voor de Timeless collectie, maar los van Bauhaus is ook de invloed van andere historische designers terug te vinden zoals onze eigen Wilhelm Marinus Dudok. Om te benadrukken dat het remakes zijn, zijn de deurkrukken vernoemd naar het jaartal waarmee verwezen wordt naar de oorsprong van het ontwerp. Authenticiteit vormt een rode draad door de hele serie waarbij in de ontwikkeling en productie rekening is gehouden met de originele kenmerken van vroeger, zoals gebruik van basismaterialen, finishes en zelf het kleinste detail zoals het gebruik van de juiste schroefjes van weleer.

Timeless. As the name implies, this assortment has stood the test of time. The series comprises products of years gone by that have been given a new lease of life by FORMANI®; some of which have been combined with elements of modern technology and functionality. Forming a great source of inspiration for the series was the BAUHAUS institute (founded in Weimar on 1 April 1919 by Walter Gropius), one of the largest art movements in Europe which arose during the Interbellum period.

To put it simply, the Bauhaus philosophy was based on simplicity and functionality. Details were omitted and the essence of a design was revealed through the beauty of simplicity. It is no coincidence then that the universally-known phrase 'Less is more' dates back to the Bauhaus period. Although the Bauhaus institute only existed for fourteen years, it put forward a concept that still exerts influence on design and architecture to this very day.

Designs by famous Bauhaus names such as Walter Gropius and Wilhelm Wagenfelt provide a source of inspiration for the Timeless collection but – aside from the Bauhaus – you can also see the influence of other historical designers, such as the Netherlands' own Wilhelm Marinus Dudok. To emphasize the fact that they are remakes, the door handles have been named after the year of their original design. Authenticity forms a common thread throughout the series, in which development and production take into account the original features of the past, such as the use of basic materials and finishes and even the smallest details, such as using the right screws.



FORMANI STORIES

STORY PEDRALBES, SPANJE STORY PEDRALBES, SPAIN	364
STORY NEERCANNE, NEDERLAND STORY NEERCANNE, THE NETHERLANDS	398
STORY BARCELONA, SPANJE STORY BARCELONA, SPAIN	426
STORY BARCELONA, SPANJE STORY BARCELONA, SPAIN	444

DEURBESLAG | DOOR FITTINGS

374

DEURKRUKKEN LEVER HANDLES	374
ACCESSOIRES DEURKRUKKEN LEVER HANDLE ACCESSORIES	393

RAAMBESLAG | WINDOW FITTINGS

406

RAAMBOOMPJES CASEMENT FASTENERS	406
RAAMBOOMPJES AFSLUITBAAR LOCKING CASEMENT FASTENERS	407
RAAMUITZETTERS CASEMENT STAYS	407
DRAAIKIEPBESLAG TILT AND TURN WINDOW HANDLES	408
KRUKESPAGNOLETTEN ESPAGNOLETTE BOLTS	417
POMPESPAGNOLETTEN ESPAGNOLETTE BOLTS	420
RAAMGREPEN WINDOW HANDLES	421

VOORDEURBESLAG | FRONT DOOR FITTINGS

423

VOORDEURKNOPPEN FRONT DOOR KNOBS	423
VEILIGHEIDSCILINDERROZETTEN SECURITY ESCUTCHEONS	424
VEILIGHEIDSSCHILDEN SECURITY PLATES	425
BRIEFPLATEN LETTER PLATES	432
BELDRUKKERS BELL PUSHES	432
HUISNUMMERS NUMERALS	433

ACCESSOIRES | ACCESSORIES

435

GREPEN PULL HANDLES	435
SCHUIFDEURKOMMEN FLUSH PULLS	437
MEUBELGREPEN CABINET HANDLES	438
MEUBELKNOPPEN CABINET KNOBS	441
KNOPPEN KNOBS	442
GLASDEURKNOPPEN GLASS DOOR KNOBS	443
DEURSTOPPEN DOOR STOPS	443



SPAIN

PEDRALBES

BES

LOCATION: PEDRALBES, SPAIN
OBJECT: PRIVATE RESIDENCE
INTERIOR DESIGN: ALBA BAGUDÀ PERICOT
PHOTOGRAPHY: TIJMEN BALLIEUX

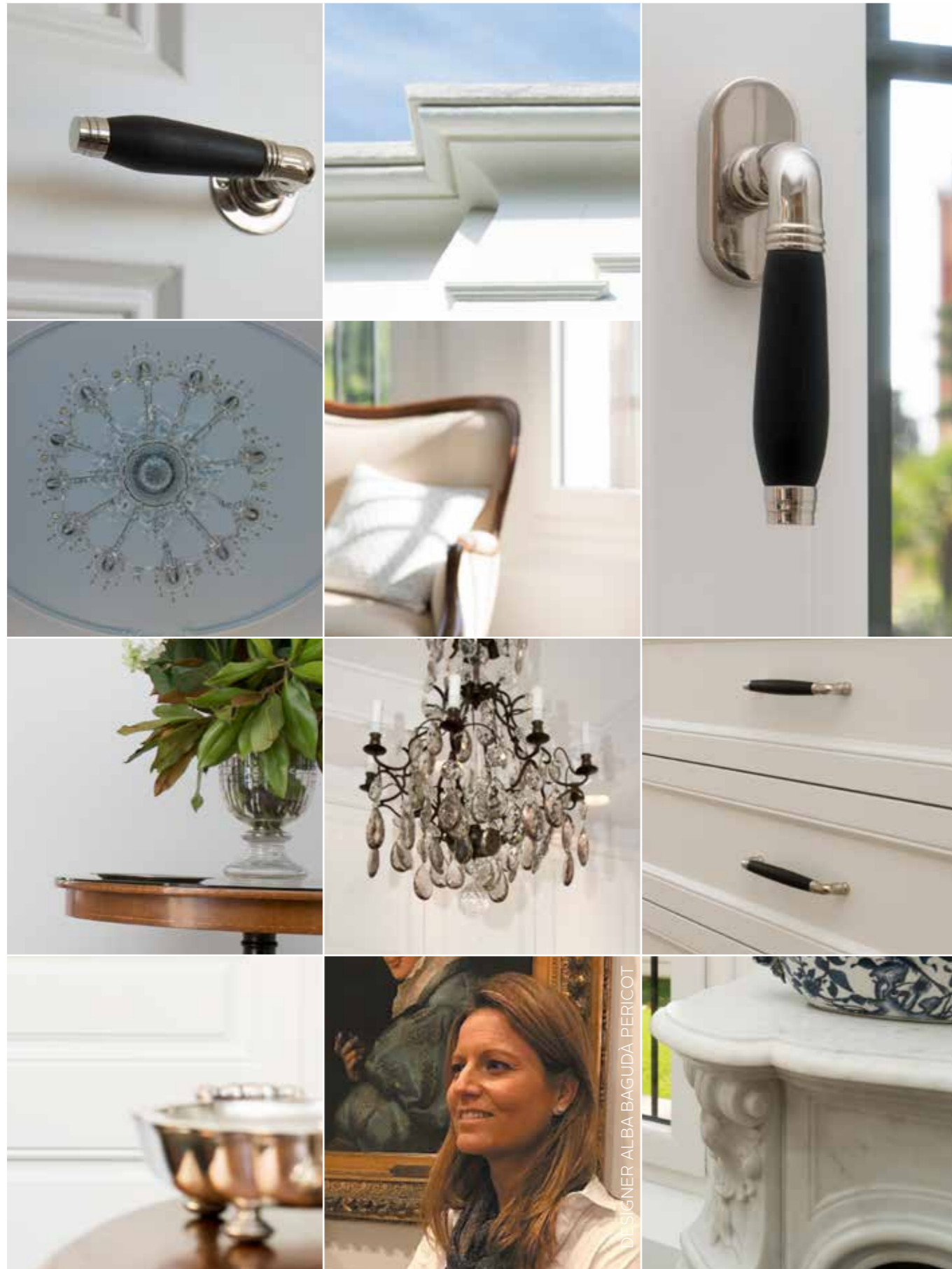

FORMANI®
TIMELESS

DESIGNER ALBA BAGUDA PERICOT



TIMELESS
1934GRR50 LEVER HANDLE BRIGHT NICKEL / EBONY WOOD



REMODELLING THE PAST

Dit prachtige huis uit 1905 is gelegen in Barcelona. Met respect voor het authentieke karakter heeft de architect het huis in de wijk Pedralbes gerestaureerd of eigenlijk geherstructureerd. Om de sfeer van het verleden optimaal te bewaken, koos Alba Bagudà Pericot voor contrasterende, hedendaagse elementen. De doorware speelt daarbij een belangrijke rol.

This beautiful house in Barcelona dates back to 1905. The architect restored or, in fact, restructured this house in the Pedralbes district with a sense of respect for its authentic character. In order to treasure the historic character of the house, Alba Bagudà Pericot selected contrasting contemporary elements. The door fittings are an important aspect of this design.

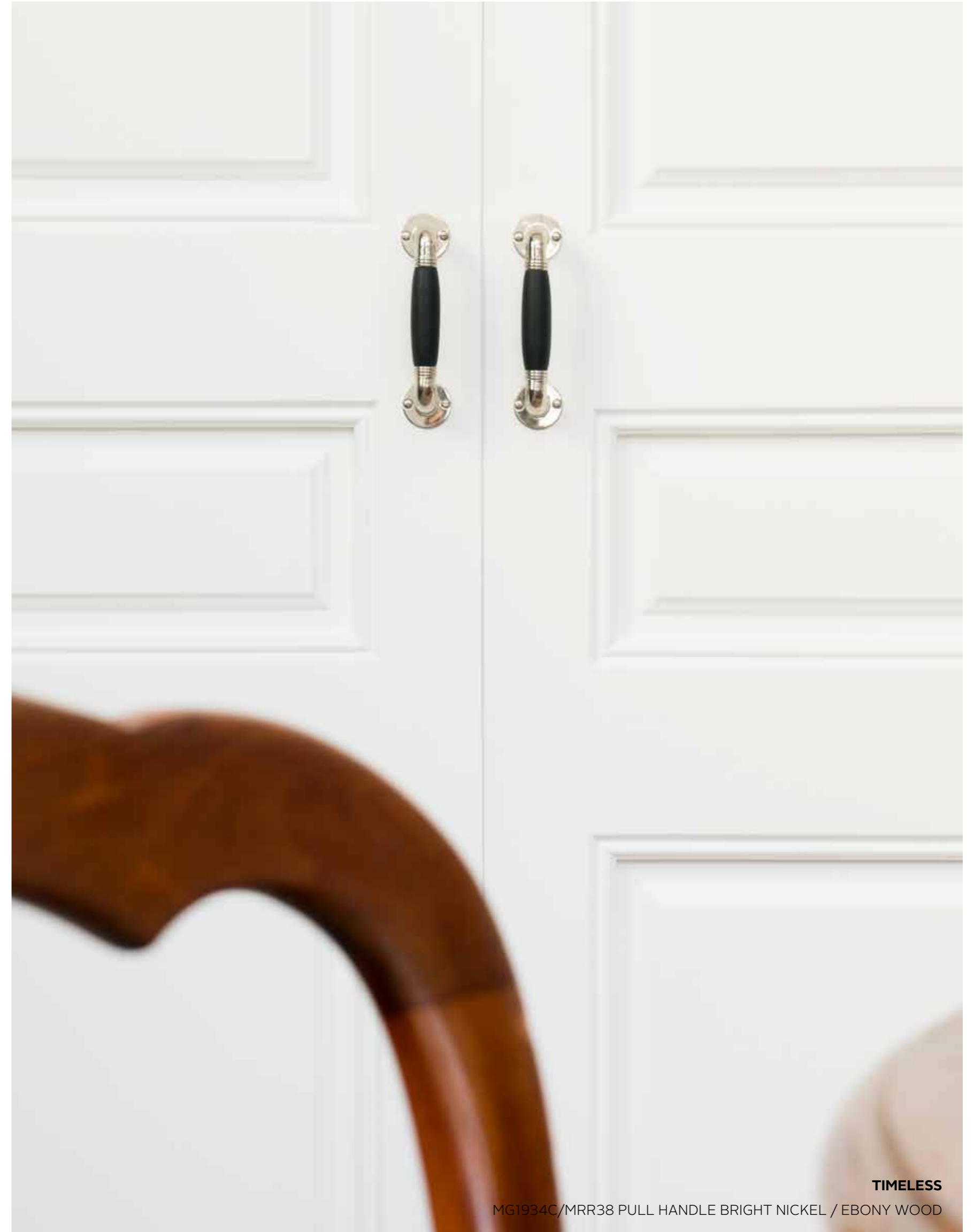

TIMELESS

MG1934C/MRR38 PULL HANDLE BRIGHT NICKEL / EBONY WOOD



TIMELESS
MG1934C/MRR38 PULL HANDLE BRIGHT NICKEL / EBONY WOOD



COMPLEMENTING CEILINGS FROM THE PAST

De keuze voor de Timeless-lijn van FORMANI® is een essentieel onderdeel van de filosofie die ten grondslag ligt aan het project. Het beslag complementeert de rijke pleisterplafonds en brengt de imposante kristallen lampen naar een hedendaags niveau. Het sluit bovendien aan bij het spel tussen zwart en wit dat is toegepast.

The selection of the FORMANI® Timeless line is an inherent part of the philosophy on which this project is based. The fittings complement the ornate plaster ceiling and brings the impressive crystal chandelier to a contemporary level. It also ties in with the interplay between black and white that has been used.



CONCEPT-ENABLING HARDWARE

De elegantie van de zwarte met glans nikkel hardware past bij de ingebrachte designelementen zoals de imposante zwarte, ijzeren wand die de eetkamer van de hal scheidt. Ook de vitrine, de witte marmeren haard uit Parijs en het beeld dat uit een antiekwinkel afkomstig is, maken deel uit van het zwart-witspel.

The elegance of the black and nickel fittings matches the added design elements such as the impressive black, metal wall that partitions the dining room. The display case, white marble hearth from Paris, and the statue purchased at an antique shop are a part of the interplay between black and white.



TIMELESS
MG1934C/MRR38 PULL HANDLE BRIGHT NICKEL / EBONY WOOD

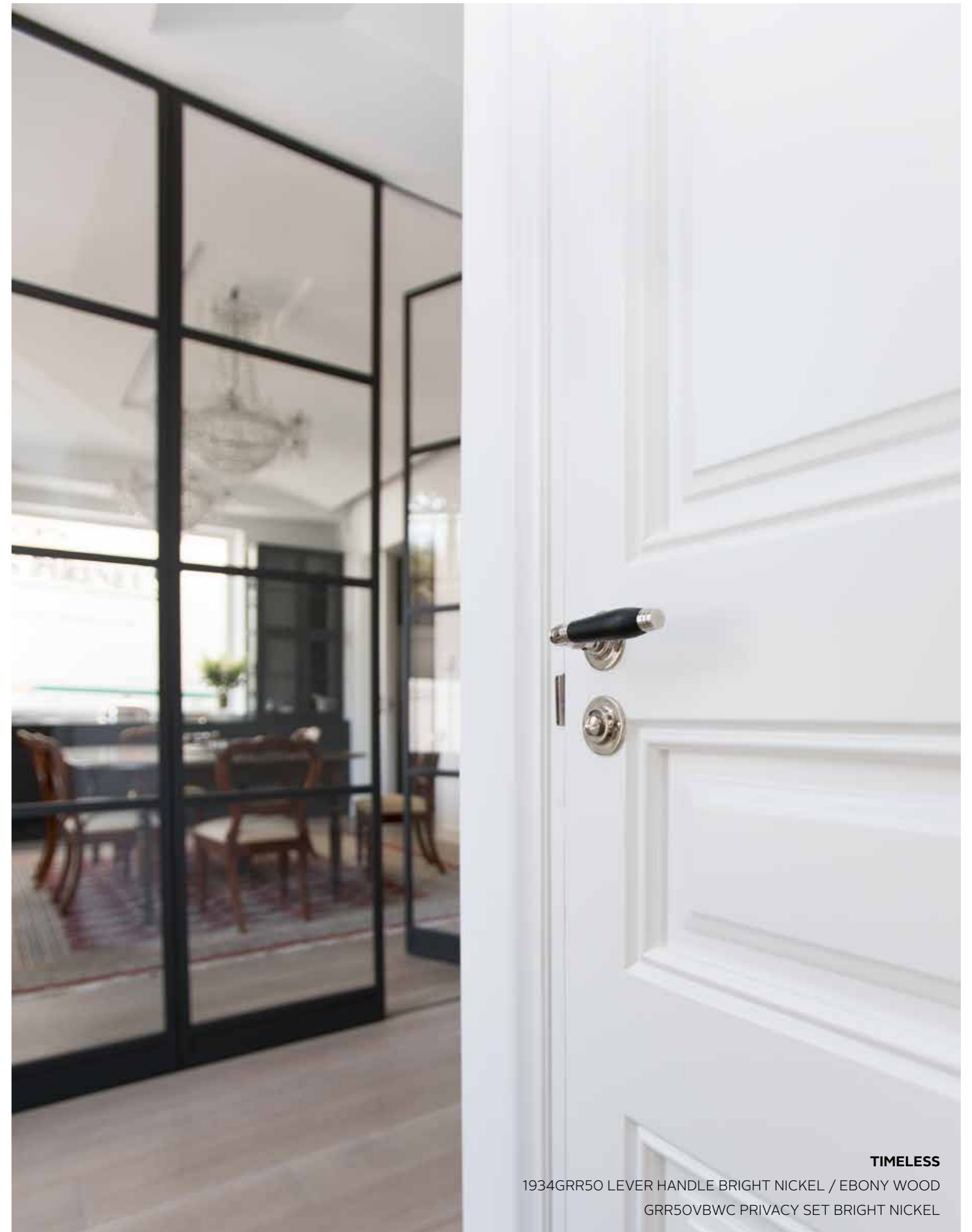

TIMELESS
1934GRR50 LEVER HANDLE BRIGHT NICKEL / EBONY WOOD
GRR50VBWC PRIVACY SET BRIGHT NICKEL

TIMELESS

DEURBESLAG | DOOR FITTINGS

1815

massieve deurkruk geveerd, vast-draaibaar op rozet op verzoek ook op schild leverbaar

solid sprung lever handle attached to rose also available on plate on request

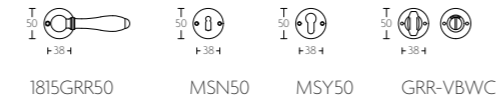
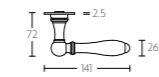

1815GRR50 MSN50 MSY50 GRR-VBWC

mat nikkel/ebbenhout
satin nickel/ebony wood

glans nikkel/ebbenhout
bright nickel/ebony wood

1910L

Chemin de fer

massieve deurkruk, ongeveer op rozet op verzoek ook op schild leverbaar

solid unsprung lever handle on rose also available on plate, on request

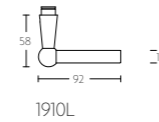

1910LMRR38 MSN38 MSY50 MRR38MWC

mat nikkel
satin nickel

glans nikkel
bright nickel

messing ongelakt
brass unlacquered

1910T

Chemin de fer

massieve deurkruk, ongeveer op rozet op verzoek ook op schild leverbaar

solid unsprung lever handle on rose also available on plate, on request

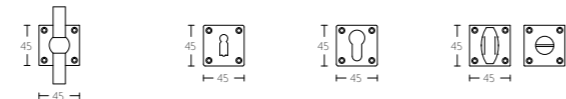
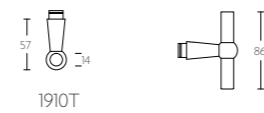

1910TMRV45 MSNV45 MSYV45 MRV45MWC

mat nikkel
satin nickel

glans nikkel
bright nickel

messing ongelakt
brass unlacquered

TIMELESS

DEURBESLAG | DOOR FITTINGS

1921

inspired by Ludwig Wittgenstein

massieve deurkruk, ongeveer op rozet op verzoek ook op schild leverbaar

solid unsprung lever handle on rose also available on plate, on request

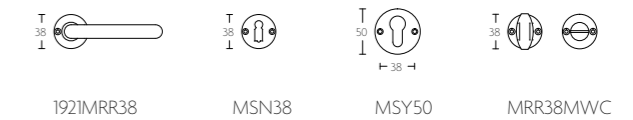
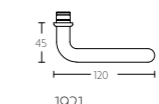

1921MRR38 MSN38 MSY50 MRR38MWC

mat nikkel
satin nickel

glans nikkel
bright nickel

1922

Nautica

massieve deurkruk, ongeveer op rozet

solid unsprung lever handle on rose

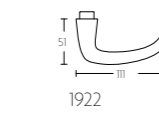

1922MRO MSN38 MSY50 MRR38MWC

mat nikkel
satin nickel

glans nikkel
bright nickel

messing ongelakt
brass unlacquered

1922

Nautica

massieve deurkruk, ongeveer op schild

solid unsprung lever handle on plate

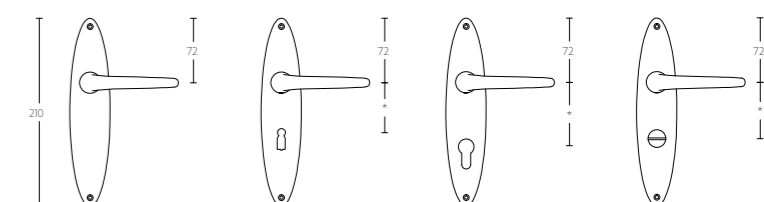
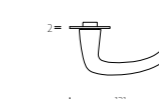

1922MPOSFC 1922MPON* 1922MPOY* 1922MPOWC*

mat nikkel
satin nickel

glans nikkel
bright nickel

messing ongelakt
brass unlacquered

* afstand opgeven bij bestelling
* state distance on order

TIMELESS

DEURBESLAG | DOOR FITTINGS

1923
inspired by Bauhaus



mat nikkel
satin nickel

glans nikkel
bright nickel

messing ongelakt
brass unlacquered

massieve deurkruk, ongeveerd op rozet | solid unsprung lever handle on rose
op verzoek ook op schild leverbaar | also available on plate, on request

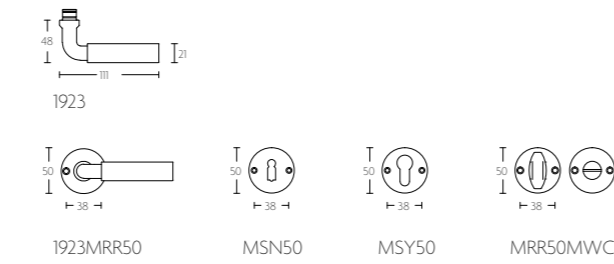

1923MRR50 MSN50 MSY50 MRR50MWC

1927
inspired by Wilhelm Wagenfeld / Bauhaus



mat nikkel
satin nickel

glans nikkel
bright nickel

messing ongelakt
brass unlacquered

massieve deurkruk, ongeveerd op rozet | solid unsprung lever handle on rose

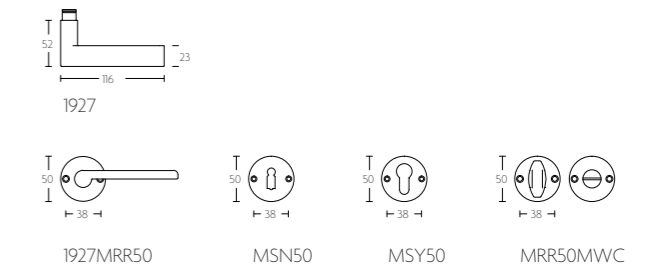

1927MRR50 MSN50 MSY50 MRR50MWC

1924
inspired by Bauhaus



mat nikkel
satin nickel

massieve deurkruk vast-draaibaar
geveerd op rozet | solid sprung lever handle
op verzoek ook op geveerd schild leverbaar | attached to rose,
also available on sprung plate
on request

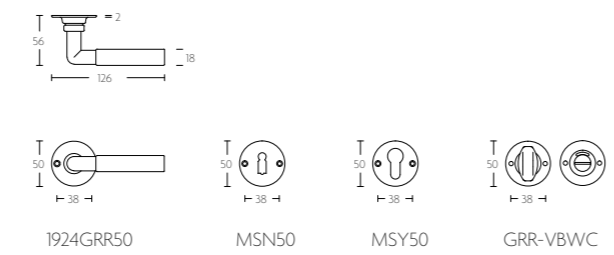

1924GRR50 MSN50 MSY50 GRR-VBWC

1927
inspired by Wilhelm Wagenfeld / Bauhaus



mat nikkel
satin nickel

glans nikkel
bright nickel

messing ongelakt
brass unlacquered

massieve deurkruk, ongeveerd op schild | solid unsprung lever handle on plate

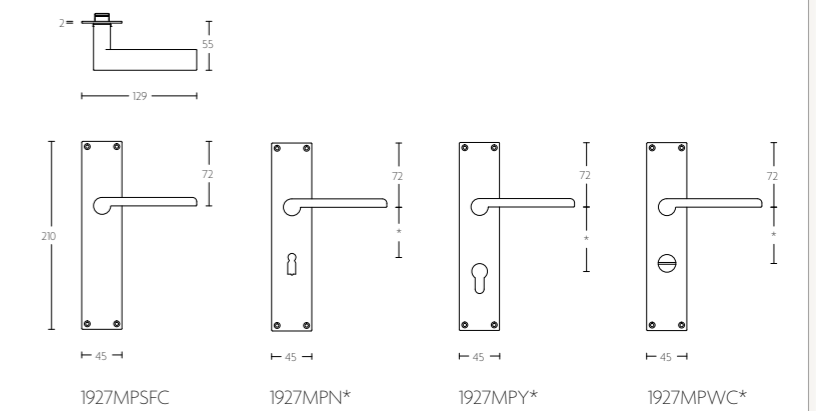

1927MPSFC 1927MPN* 1927MPY* 1927MPWC*

* afstand opgeven bij bestelling
* state distance on order

1925
inspired by Ferdinand Kramer / Bauhaus



mat nikkel
satin nickel

glans nikkel
bright nickel

messing ongelakt
brass unlacquered

massieve deurkruk, ongeveerd op rozet | solid unsprung lever handle on rose
op verzoek ook op schild leverbaar | also available on plate, on request

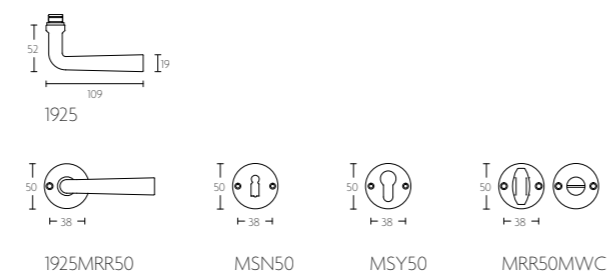

1925MRR50 MSN50 MSY50 MRR50MWC

1929
Villa Feltrinelli



mat nikkel
satin nickel

glans nikkel
bright nickel

messing ongelakt
brass unlacquered

massieve deurkruk, ongeveerd op rozet | solid unsprung lever handle on rose

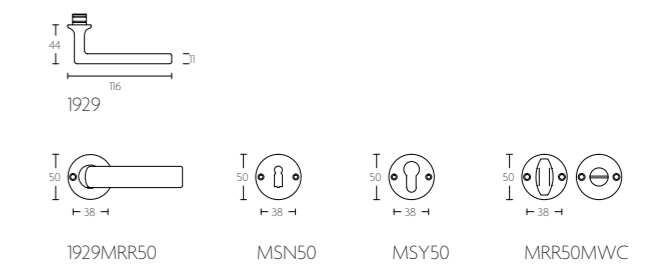

1929MRR50 MSN50 MSY50 MRR50MWC

TIMELESS

DEURBESLAG | DOOR FITTINGS

1929

Villa Feltrinelli

massieve deurkruk, ongeveerd op schild | solid unsprung lever handle on plate



mat nikkel
satin nickel

glans nikkel
bright nickel

messing ongelakt
brass unlacquered

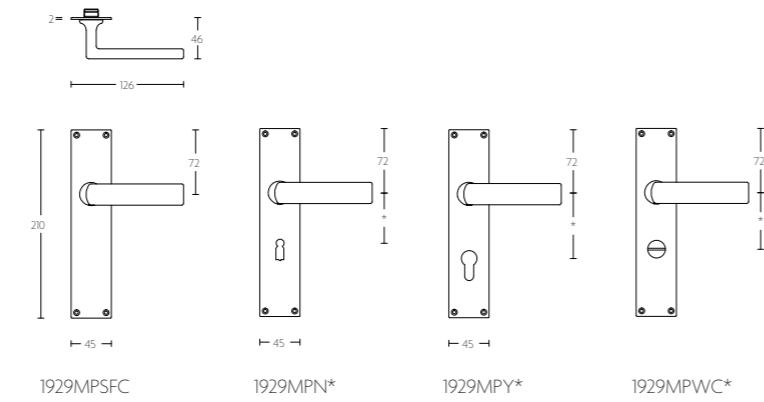

* afstand opgeven bij bestelling
* state distance on order

1930

inspired by Walter Gropius / Bauhaus

massieve deurkruk, ongeveerd op rozet | solid unsprung lever handle on rose



mat nikkel
satin nickel

glans nikkel
bright nickel

messing ongelakt
brass unlacquered

mat nikkel/ebenhout
satin nickel/ebony wood

glans nikkel/ebenhout
bright nickel/ebony wood

messing ongelakt/ebenhout
brass unlacquered/ebony wood

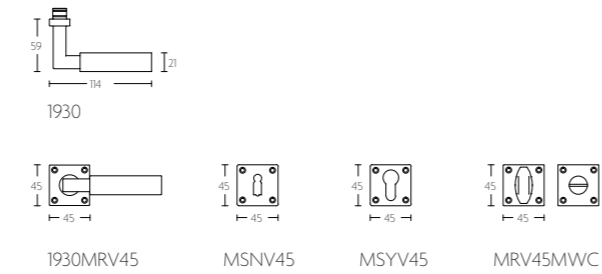

1930

inspired by Walter Gropius / Bauhaus

massieve deurkruk, ongeveerd op schild | solid unsprung lever handle on plate



- mat nikkel
satin nickel
- glans nikkel
bright nickel
- messing ongelakt
brass unlacquered
- mat nikkel/ebenhout
satin nickel/ebony wood
- glans nikkel/ebenhout
bright nickel/ebony wood
- messing ongelakt/ebenhout
brass unlacquered/ebony wood

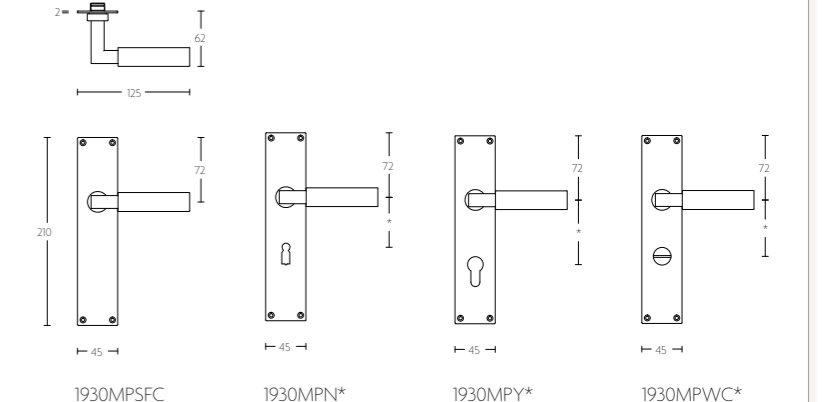

* afstand opgeven bij bestelling
* state distance on order

1930XL

inspired by Walter Gropius / Bauhaus

massieve deurkruk, ongeveerd op rozet op verzoek ook op schild leverbaar | solid unsprung lever handle on rose also available on plate, on request



mat nikkel/ebenhout
satin nickel/ebony wood

glans nikkel/ebenhout
bright nickel/ebony wood

messing ongelakt/ebenhout
brass unlacquered/ebony wood

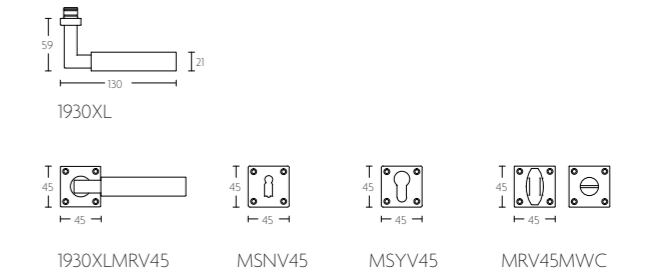

1930

inspired by Walter Gropius / Bauhaus

massieve deurkruk ongeveerd op rozet | solid lever handle unsprung on rose



PVD mat nikkel
PVD satin nickel

PVD glans nikkel
PVD bright nickel

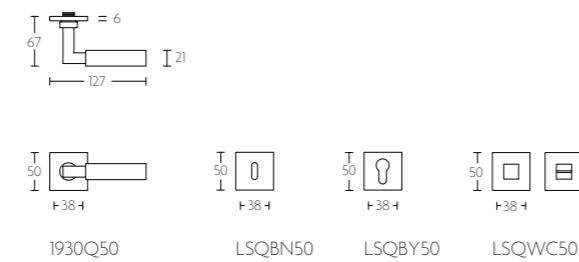

1930XL DELUXE

inspired by Walter Gropius / Bauhaus

massieve deurkruk geveerd, vast-draaibaar op rozet op verzoek ook op schild leverbaar | solid sprung lever handle attached to rose also available on plate, on request



mat nikkel / bruin leer
satin nickel / brown leather

glans nikkel / bruin leer
bright nickel / brown leather

mat nikkel / zwart leer
satin nickel / black leather

glans nikkel / zwart leer
bright nickel / black leather

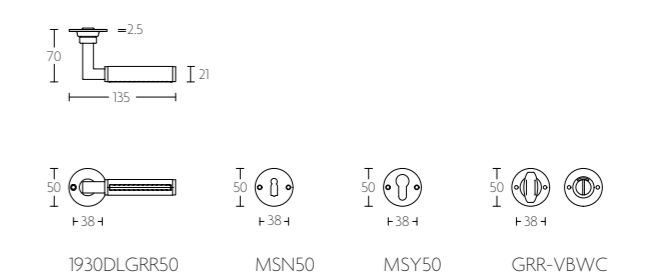

TIMELESS

DEURBESLAG | DOOR FITTINGS

1931
Amsterdam

massieve deurkruk, ongeveerd op rozet | solid unsprung lever handle on rose
op verzoek ook op schild leverbaar | also available on plate, on request







1931MRO MSN38 MSY50 MRR38MWC



mat nikkel/ebbenhout
satin nickel/ebony wood

glans nikkel/ebbenhout
bright nickel/ebony wood

messing ongelakt/ebbenhout
brass unlacquered/ebony wood

1931
Amsterdam

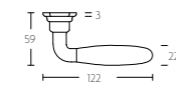
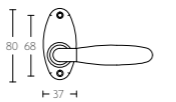
massieve deurkruk vast-draaibaar
geveerd op rozet | solid sprung lever handle
op verzoek ook op schild leverbaar | attached to rose
also available on plate, on request

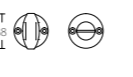







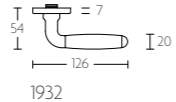

1931GRO MSN38 MSY50 MRR38MWC

mat nikkel/ebbenhout
satin nickel/ebony wood

1932
tonmodel

massieve deurkruk,
geveerd of ongeveerd op rozet | solid sprung or unsprung lever
handle on rose

1932PR FBNPR FBYPR F896WCPR

PVD mat nikkel/bakeliet
PVD satin nickel/bakelite



PVD glans nikkel/bakeliet
PVD bright nickel/bakelite

TIMELESS

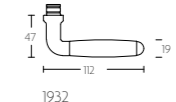
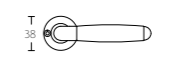

DEURBESLAG | DOOR FITTINGS

1932
tonmodel

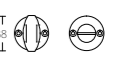

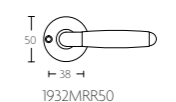

massieve deurkruk, ongeveerd op rozet | solid unsprung lever handle on rose

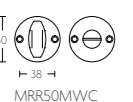

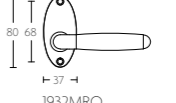

1932MRR38 MSN38 MSY50 MRR38MWC



1932MRR50 MSN50 MSY50 MRR50MWC

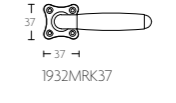



1932MRO MSN38 MSY50 MRR38MWC

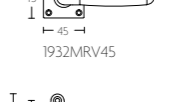

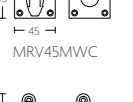
1932MRK37 MSNK37 MSYK37 MRK37MWC

1932MRV45 MSNV45 MSYV45 MRV45MWC

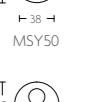
1932MRL MSN38 MSY50 MRLMWC

1932MRC50 MNC50 MYC50 MRC50MWC

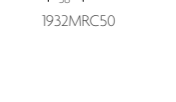
mat nikkel/ebbenhout
satin nickel/ebony wood

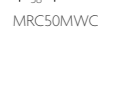
glans nikkel/ebbenhout
bright nickel/ebony wood

messing ongelakt/ebbenhout
brass unlacquered/ebony wood

1932
tonmodel

massieve deurkruk, ongeveerd op schild | solid unsprung lever handle on plate



mat nikkel/ebbenhout
satin nickel/ebony wood



glans nikkel/ebbenhout
bright nickel/ebony wood



messing ongelakt/ebbenhout
brass unlacquered/ebony wood

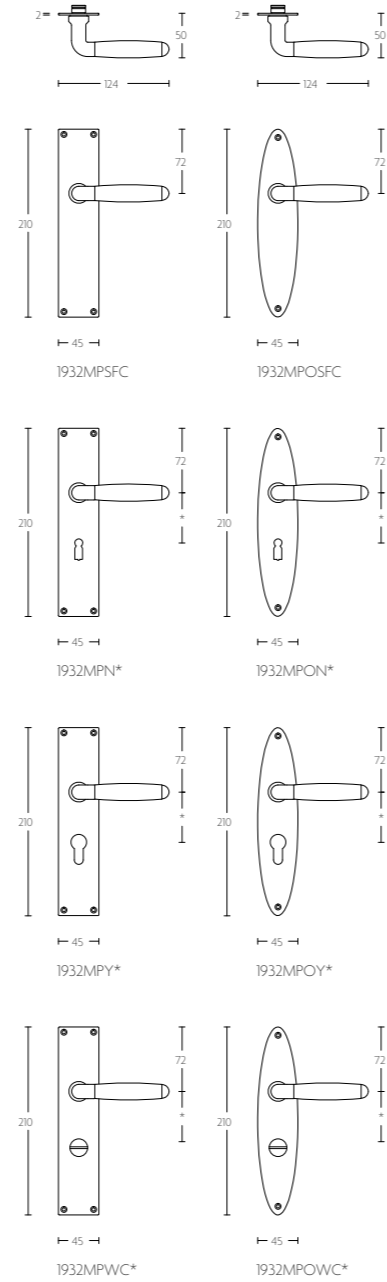

* afstand opgeven bij bestelling
* state distance on order

1932
tonmodel

massieve deurkruk vast-draaibaar
geveerd op rozet
op verzoek ook op schild leverbaar

solid sprung lever handle
attached to rose
also available on plate, on request



mat nikkel/ebbenhout
satin nickel/ebony wood



glans nikkel/ebbenhout
bright nickel/ebony wood

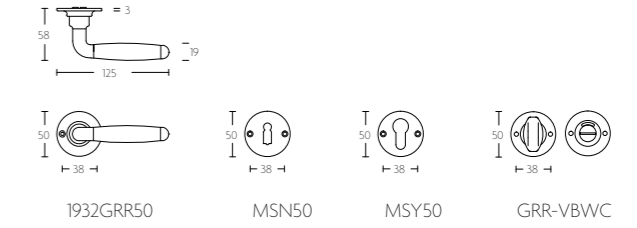

1932
tonmodel

massieve deurkruk vast-draaibaar
geveerd op rozet
op verzoek ook op schild leverbaar

solid sprung lever handle
attached to rose
also available on plate, on request



mat nikkel/ebbenhout
satin nickel/ebony wood



glans nikkel/ebbenhout
bright nickel/ebony wood

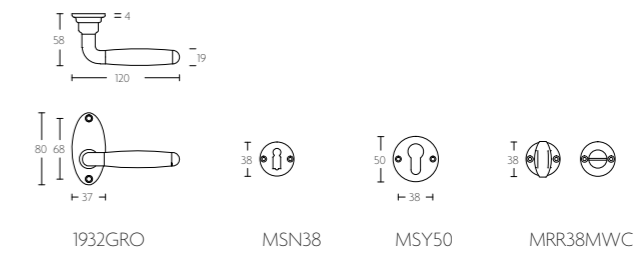

1932
tonmodel

massieve deurkruk vast-draaibaar
geveerd op rozet
op verzoek ook op schild leverbaar

solid sprung lever handle
attached to rose
also available on plate, on request



mat nikkel/ebbenhout
satin nickel/ebony wood



glans nikkel/ebbenhout
bright nickel/ebony wood

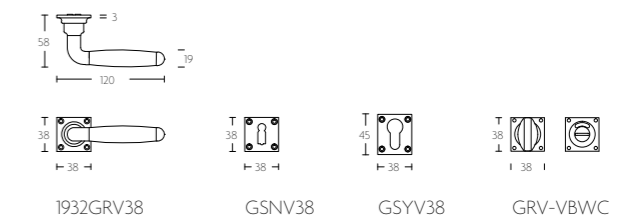

TIMELESS

DEURBESLAG | DOOR FITTINGS

1932
tonmodel



mat nikkel/ebbenhout
satin nickel/ebony wood

massieve deurkruk vast-draaibaar
geveerd op schild | solid sprung lever handle
attached to plate

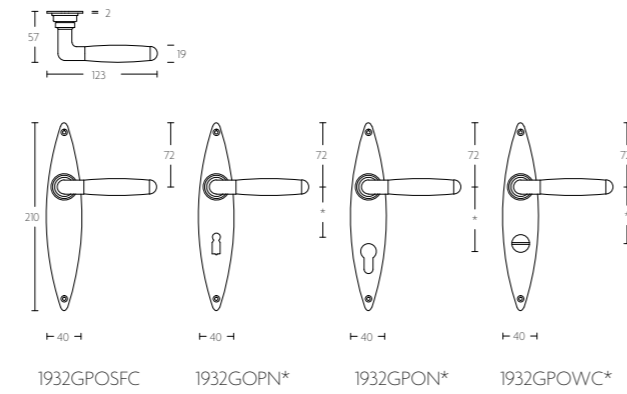

1932GPOSFC 1932GOPN* 1932GPON* 1932GPOWC*

* afstand opgeven bij bestelling
* state distance on order

TIMELESS

DEURBESLAG | DOOR FITTINGS

1932T
tonmodel



mat nikkel/ebbenhout
satin nickel/ebony wood



glans nikkel/ebbenhout
bright nickel/ebony wood



messing ongelakt/ebbenhout
brass unlacquered/ebony wood

massieve deurkruk, ongeveer op rozet
op verzoek ook op schild leverbaar | solid unsprung lever handle on rose
also available on plate, on request

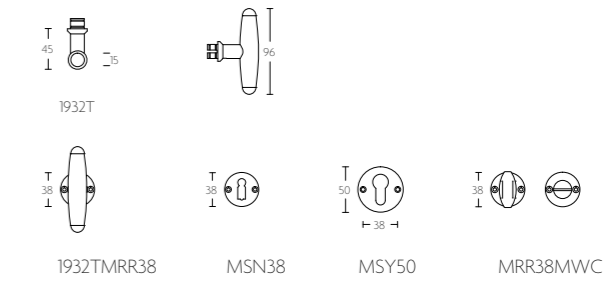

1932TMRR38 MSN38 MSY50 MRR38MWC

1932XL
tonmodel



mat nikkel/ebbenhout
satin nickel/ebony wood

glans nikkel/ebbenhout
bright nickel/ebony wood

massieve deurkruk geveerd, vast-draaibaar
op rozet | solid sprung lever handle attached
to rose
op verzoek ook op schild leverbaar | also available on plate, on request

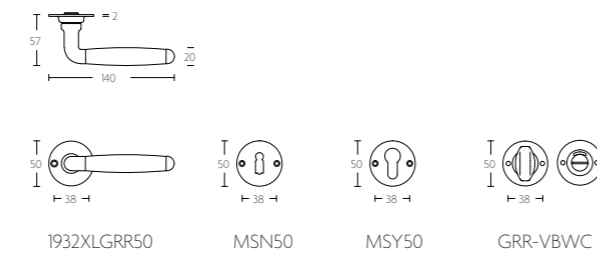

1932XLGRR50 MSN50 MSY50 GRR-VBWC

1934
Stokstraat



mat nikkel/ebbenhout
satin nickel/ebony wood



glans nikkel/ebbenhout
bright nickel/ebony wood



messing ongelakt/ebbenhout
brass unlacquered/ebony wood

massieve deurkruk vast-draaibaar
geveerd op rozet | solid sprung lever handle
attached to rose

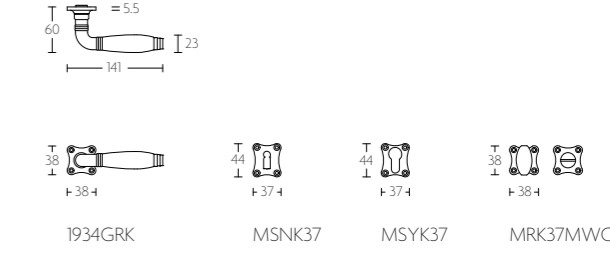

1934GRK MSNK37 MSYK37 MRK37MWC

1932XL DELUXE
tonmodel



mat nikkel / bruin leer
satin nickel / brown leather

glans nikkel / bruin leer
bright nickel / brown leather



mat nikkel / zwart leer
satin nickel / black leather

glans nikkel / zwart leer
bright nickel / black leather

massieve deurkruk geveerd, vast-draaibaar
op rozet | solid sprung lever handle attached
to rose
op verzoek ook op schild leverbaar | also available on plate, on request

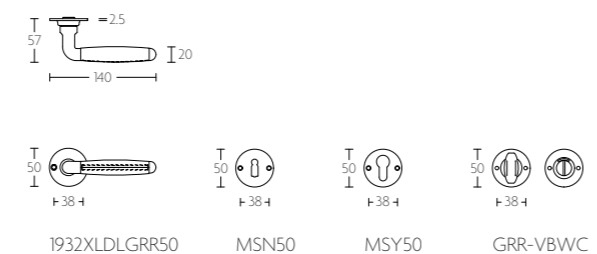

1932XLDLGR50 MSN50 MSY50 GRR-VBWC

1934
Stokstraat

massieve deurkruk, ongeveerd op rozet | solid unsprung lever handle on rose



mat nikkel/ebbenhout
satin nickel/ebony wood



glans nikkel /ebbenhout
bright nickel/ebony wood



messing ongelakt/ebbenhout
brass unlacquered/ebony wood

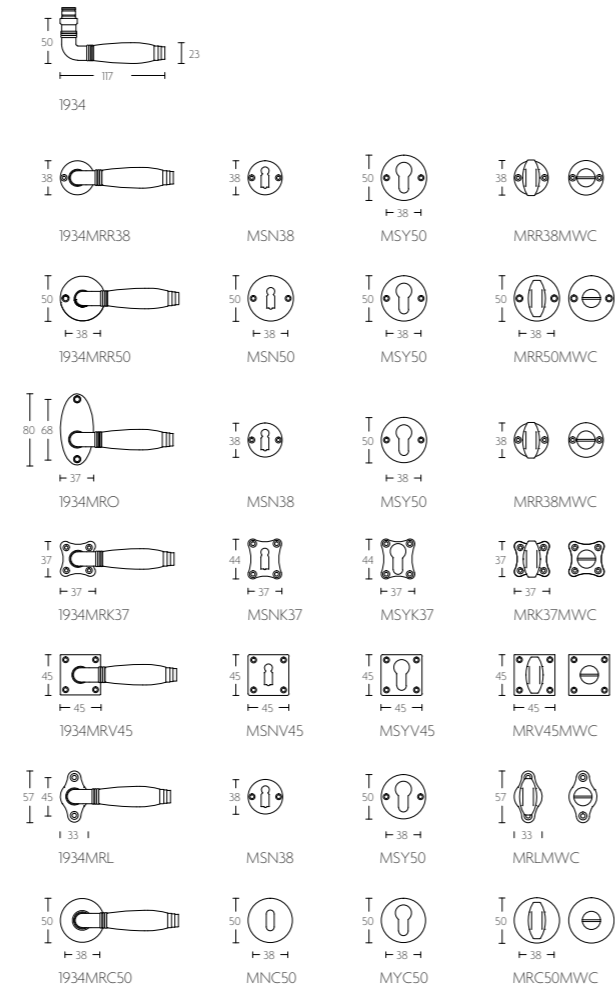

1934
Stokstraat

massieve deurkruk, ongeveerd op schild | solid unsprung lever handle on plate



mat nikkel/ebbenhout
satin nickel/ebony wood



glans nikkel/ebbenhout
bright nickel/ebony wood



messing ongelakt/ebbenhout
brass unlacquered/ebony wood

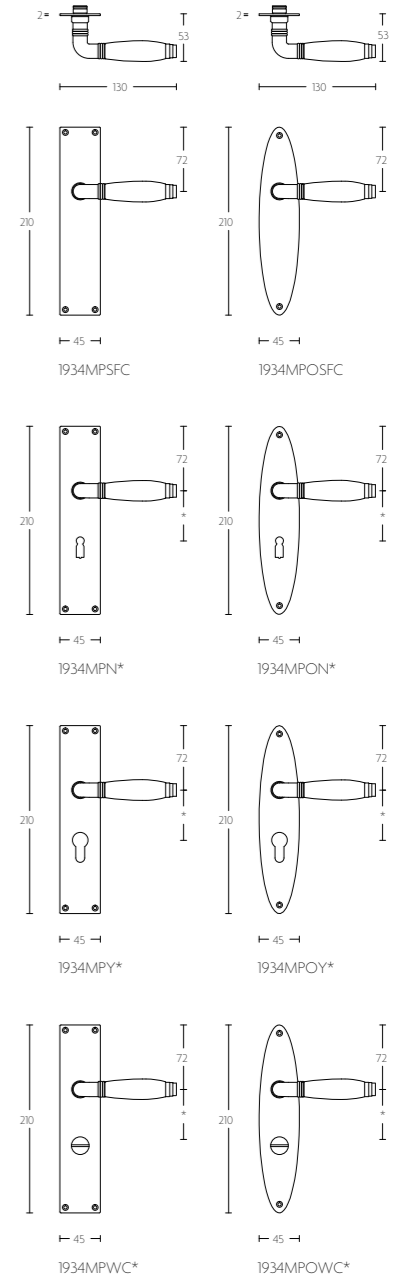



* afstand opgeven bij bestelling
* state distance on order

TIMELESS

DEURBESLAG | DOOR FITTINGS

1934
Stokstraat

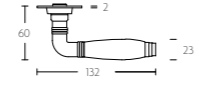
massieve deurkruk vast-draaibaar
geveerd op rozet | solid sprung lever handle
attached to rose

1934GRR50 MSN50 MSY50 GRR-VBWC



mat nikkel/ebbenhout
satin nickel/ebony wood

glans nikkel /ebbenhout
bright nickel/ebony wood

messing ongelakt/ebbenhout
brass unlacquered/ebony wood

1935

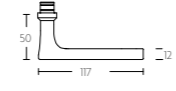
massieve deurkruk, ongeveerd op rozet | solid unsprung lever handle on rose

1935MRR50 MSN50 MSY50 MRR50MWC



mat nikkel
satin nickel

glans nikkel
bright nickel

messing ongelakt
brass unlacquered

1935

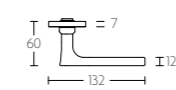
massieve deurkruk op rozet
geveerd cq. ongeveerd leverbaar | solid lever handle on rose
available sprung and/or unsprung

1935PR FBNPR FBYP F896WCPR

PVD mat nikkel
PVD satin nickel

TIMELESS

DEURBESLAG | DOOR FITTINGS

1935

massieve deurkruk, ongeveerd op schild | solid unsprung lever handle on plate

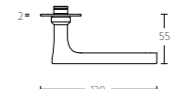
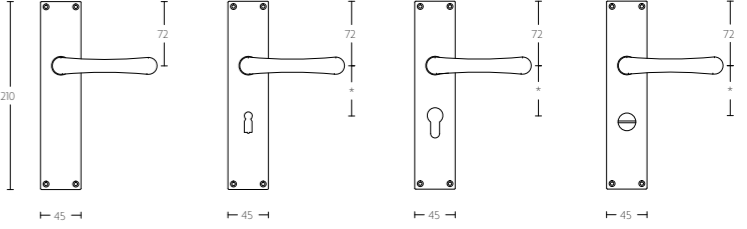
1935MPSFC 1935MPN* 1935MPY* 1935MPWC*

mat nikkel
satin nickel



glans nikkel
bright nickel

messing ongelakt
brass unlacquered

* afstand opgeven bij bestelling
* state distance on order

1935

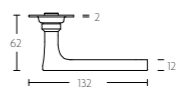
massieve deurkruk vast-draaibaar
geveerd op rozet | solid sprung lever handle
attached to rose

1935GRR50 MSN50 MSY50 GRR-VBWC



mat nikkel
satin nickel

glans nikkel
bright nickel

messing ongelakt
brass unlacquered

1938
inspired by Willem Marinus Dudok

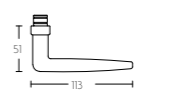
massieve deurkruk, ongeveerd op rozet | solid unsprung lever handle on rose

1938MRR50 MSN50 MSY50 MRR50MWC

mat nikkel
satin nickel

glans nikkel
bright nickel

messing ongelakt
brass unlacquered

mat zwart
satin black

TIMELESS

DEURBESLAG | DOOR FITTINGS

1938
inspired by Willem Marinus Dudok



PVD mat nikkel
PVD satin nickel

PVD glans nikkel
PVD bright nickel

massieve deurkruk op rozet
geveerd cq. ongeveerd leverbaar | solid lever handle on rose
available sprung and/or unsprung

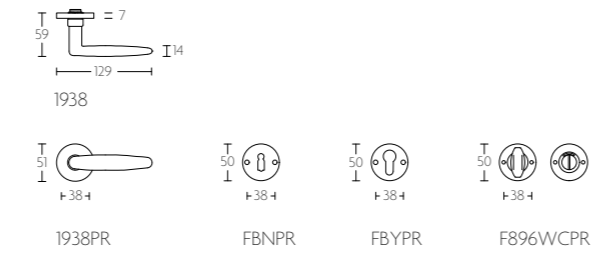

1938PR FBINPR FBYP F896WCPR

1938
inspired by Willem Marinus Dudok



mat nikkel
satin nickel

massieve deurkruk vast-draaibaar
geveerd op schild | solid sprung lever handle
attached to plate

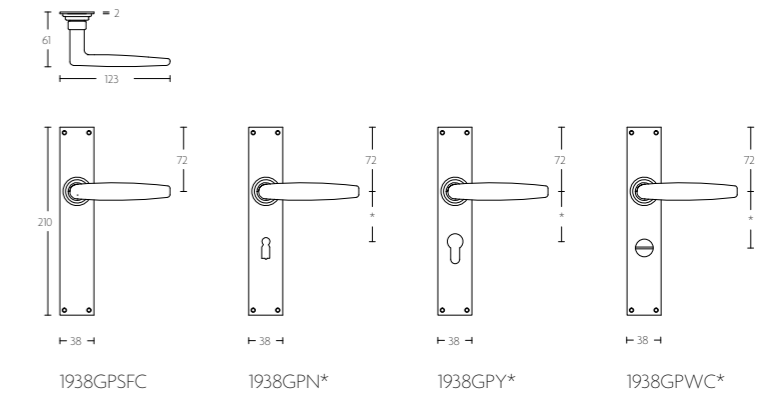

1938GPSFC 1938GPN* 1938GPY* 1938GPWC*

* afstand opgeven bij bestelling
* state distance on order

1938
inspired by Willem Marinus Dudok



mat nikkel
satin nickel

glans nikkel
bright nickel

messing ongelakt
brass unlacquered

massieve deurkruk, ongeveerd op schild | solid unsprung lever handle on plate

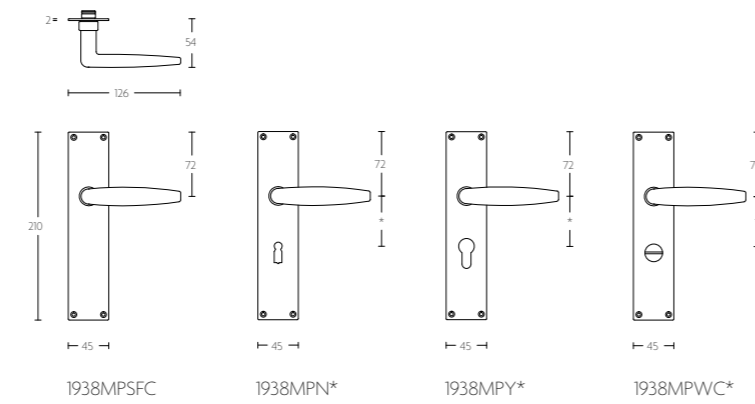

1938MP5FC 1938MPN* 1938MPY* 1938MPWC*

* afstand opgeven bij bestelling
* state distance on order

1939
inspired by Willem Marinus Dudok



mat nikkel
satin nickel

glans nikkel
bright nickel

massieve deurkruk geveerd, vast-draaibaar
op rozet | solid sprung lever handle attached
to rose | also available on plate, on request

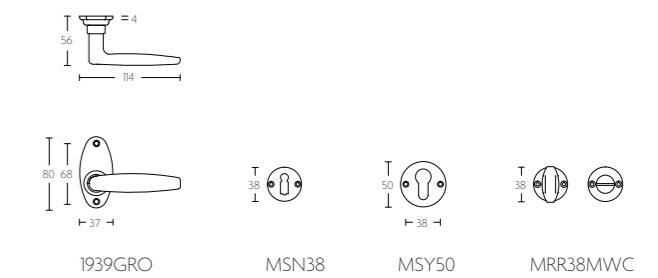

1939GRO MSN38 MSY50 MRR38MWC

1938
inspired by Willem Marinus Dudok



mat nikkel
satin nickel

glans nikkel
bright nickel

mat zwart
satin black

massieve deurkruk vast-draaibaar
geveerd op rozet | solid sprung lever handle
attached to rose

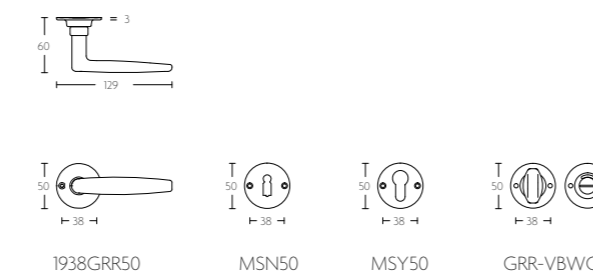

1938GRR50 MSN50 MSY50 GRR-VBWC

1940



mat nikkel
satin nickel

glans nikkel
bright nickel

massieve deurkruk geveerd, vast-draaibaar
op rozet | solid sprung lever handle attached
to rose | also available on plate, on request

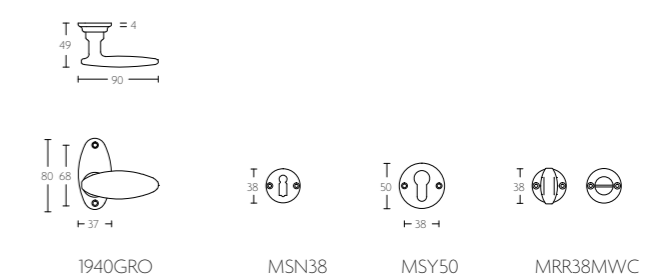

1940GRO MSN38 MSY50 MRR38MWC

TIMELESS

DEURBESLAG | DOOR FITTINGS

1946

massieve deurkruk geveerd, vast-draaibaar op rozet
op verzoek ook op schild leverbaar

solid sprung lever handle attached to rose
also available on plate, on request

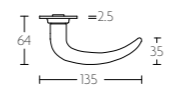
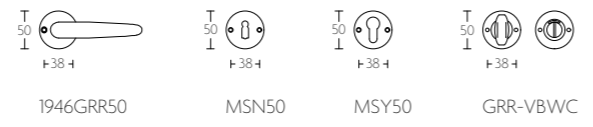
1946GRR50 MSN50 MSY50 GRR-VBWC

mat nikkel
satin nickel



glans nikkel
bright nickel

messing ongelakt
brass unlacquered

1948

massieve deurkruk op rozet geveerd cq. ongeveerd leverbaar
op verzoek ook op schild leverbaar

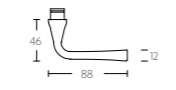
solid lever handle on rose available sprung and/or unsprung
also available on plate, on request

1948MRL/1948GRL MSN38 MSY50 MRLMWC

mat nikkel
satin nickel



glans nikkel
bright nickel

messing ongelakt
brass unlacquered

1949

massieve knopkruk ongeveer op rozet
op verzoek ook op schild leverbaar

solid unsprung knob to operate on rose
also available on plate, on request

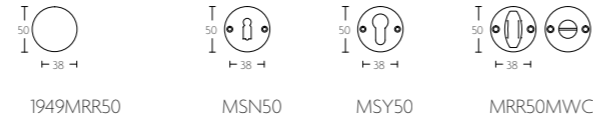
1949MRR50 MSN50 MSY50 MRR50MWC

mat nikkel
satin nickel

glans nikkel
bright nickel

messing ongelakt
brass unlacquered

TIMELESS

DEURBESLAG | DOOR FITTINGS

1952

massieve deurkruk geveerd, vast-draaibaar op rozet
op verzoek ook op schild leverbaar

solid sprung lever handle attached to rose
also available on plate, on request





1952GRR50 MSN50 MSY50 GRR-VBWC

mat nikkel/ebbenhout
satin nickel/ebony wood

glans nikkel/ebbenhout
bright nickel/ebony wood

1952 DELUXE

massieve deurkruk geveerd, vast-draaibaar op rozet
op verzoek ook op schild leverbaar

solid sprung lever handle attached to rose
also available on plate, on request

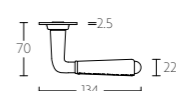
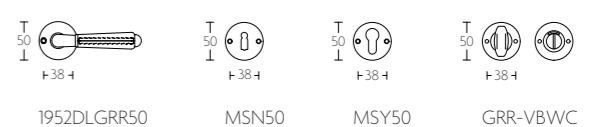
1952DLGRR50 MSN50 MSY50 GRR-VBWC

mat nikkel / bruin leer
satin nickel / brown leather

glans nikkel / bruin leer
bright nickel / brown leather

mat nikkel / zwart leer
satin nickel / black leather

glans nikkel / zwart leer
bright nickel / black leather

MSNK37

sleutelplaatje | key escutcheon

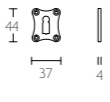
MSNK37

mat nikkel
satin nickel

glans nikkel
bright nickel

messing ongelakt
brass unlacquered

GSNV38

sleutelplaatje | key escutcheon

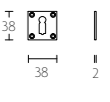
GSNV38

mat nikkel
satin nickel

glans nikkel
bright nickel

messing ongelakt
brass unlacquered

TIMELESS

DEURBESLAG | DOOR FITTINGS

MSN38 sleutelplaatje | key escutcheon

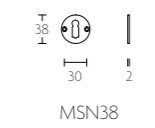
MSN38

- mat nikkel / satin nickel
- glans nikkel / bright nickel
- messing ongelakt / brass unlacquered
- mat zwart / satin black

MSNV45 sleutelplaatje | key escutcheon



MSNV45

- mat nikkel / satin nickel
- glans nikkel / bright nickel
- messing ongelakt / brass unlacquered

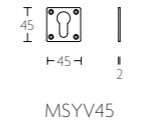

MSYV45 cilinderplaatje | profile cylinder escutcheon

MSYV45

- mat nikkel / satin nickel
- glans nikkel / bright nickel
- messing ongelakt / brass unlacquered



MYC50 cilinderplaatje | profile cylinder escutcheon

MYC50

- mat nikkel / satin nickel
- glans nikkel / bright nickel
- messing ongelakt / brass unlacquered



MNC50 sleutelplaatje | key escutcheon

MNC50

- mat nikkel / satin nickel
- glans nikkel / bright nickel
- messing ongelakt / brass unlacquered

MSN50 sleutelplaatje | key escutcheon

MSN50

- mat nikkel / satin nickel
- glans nikkel / bright nickel
- messing ongelakt / brass unlacquered
- PVD mat nikkel / PVD satin nickel
- PVD glans nikkel / PVD bright nickel

MSY50 cilinderplaatje | profile cylinder escutcheon

MSY50

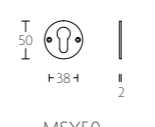
- mat nikkel / satin nickel
- glans nikkel / bright nickel
- messing ongelakt / brass unlacquered
- PVD mat nikkel / PVD satin nickel
- mat zwart / satin black

MRKB37 blind plaatje | blank escutcheon

MRKB37

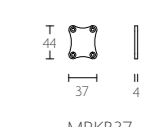
- mat nikkel / satin nickel
- glans nikkel / bright nickel
- messing ongelakt / brass unlacquered

MSYK37 cilinderplaatje | profile cylinder escutcheon

MSYK37

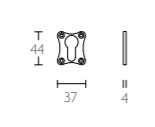
- mat nikkel / satin nickel
- glans nikkel / bright nickel
- messing ongelakt / brass unlacquered

GSYV38 cilinderplaatje | profile cylinder escutcheon

GSYV38

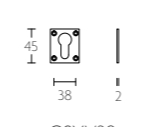
- mat nikkel / satin nickel
- glans nikkel / bright nickel
- messing ongelakt / brass unlacquered

GSVB38 blind plaatje | blank escutcheon

GSVB38

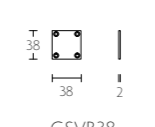
- mat nikkel / satin nickel
- glans nikkel / bright nickel
- messing ongelakt / brass unlacquered

MRB38 blind plaatje | blank escutcheon

MRB38

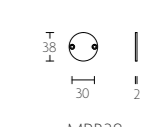
- mat nikkel / satin nickel
- glans nikkel / bright nickel
- messing ongelakt / brass unlacquered
- mat zwart / satin black

TIMELESS

DEURBESLAG | DOOR FITTINGS

MRVB45 blind plaatje | blank escutcheon



MRVB45

- mat nikkel satin nickel
- glans nikkel bright nickel
- messing ongelakt brass unlacquered

MRCB50 blind plaatje | blank escutcheon

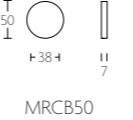
MRCB50

- mat nikkel satin nickel
- glans nikkel bright nickel
- messing ongelakt brass unlacquered

MRB50 blind plaatje | blank escutcheon

MRB50

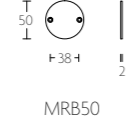
- mat nikkel satin nickel
- glans nikkel bright nickel
- messing ongelakt brass unlacquered

GRR-VBWC toiletgarnituur met tekst "vrij/bezet" | turn and release set with text "vrij/bezet"



GRR-VBWC

- mat nikkel satin nickel
- glans nikkel bright nickel
- messing ongelakt brass unlacquered
- mat zwart satin black

GRV-VBWC toiletgarnituur met tekst "vrij/bezet" | turn and release set with text "vrij/bezet"



GRV-VBWC

- mat nikkel satin nickel
- glans nikkel bright nickel
- messing ongelakt brass unlacquered

MRK37MWC toiletgarnituur | turn and release set



MRK37MWC

- mat nikkel satin nickel
- glans nikkel bright nickel
- messing ongelakt brass unlacquered

TIMELESS

DEURBESLAG | DOOR FITTINGS

MRLMWC toiletgarnituur | turn and release set



MRLMWC

- mat nikkel satin nickel
- glans nikkel bright nickel
- messing ongelakt brass unlacquered

MRR38MWC toiletgarnituur | turn and release set



MRR38MWC

- mat nikkel satin nickel
- glans nikkel bright nickel
- messing ongelakt brass unlacquered
- mat zwart satin black

MRV45MWC toiletgarnituur | turn and release set



MRV45MWC

- mat nikkel satin nickel
- glans nikkel bright nickel
- messing ongelakt brass unlacquered

MRC50MWC toiletgarnituur | turn and release set



MRC50MWC

- mat nikkel satin nickel
- glans nikkel bright nickel
- messing ongelakt brass unlacquered

MRR50MWC toiletgarnituur | turn and release set



MRR50MWC

- mat nikkel satin nickel
- glans nikkel bright nickel
- messing ongelakt brass unlacquered

WCO toiletoverslag tbv naar buitendraaiende deur | turn and release set for outward opening door

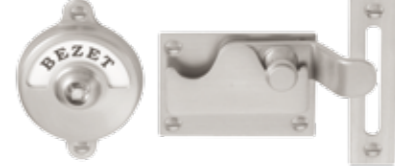
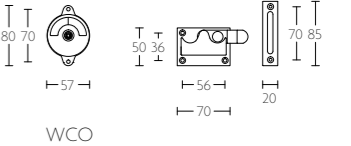
WCO

- mat nikkel satin nickel
- glans nikkel bright nickel
- messing ongelakt brass unlacquered
- mat zwart satin black

THE NETHER LANDS

NEER CANNE



LOCATION: MAASTRICHT, THE NETHERLANDS
OBJECT: CHÂTEAU NEERCANNE
PHOTOGRAPHY: TYCHO MERIJN ROEST

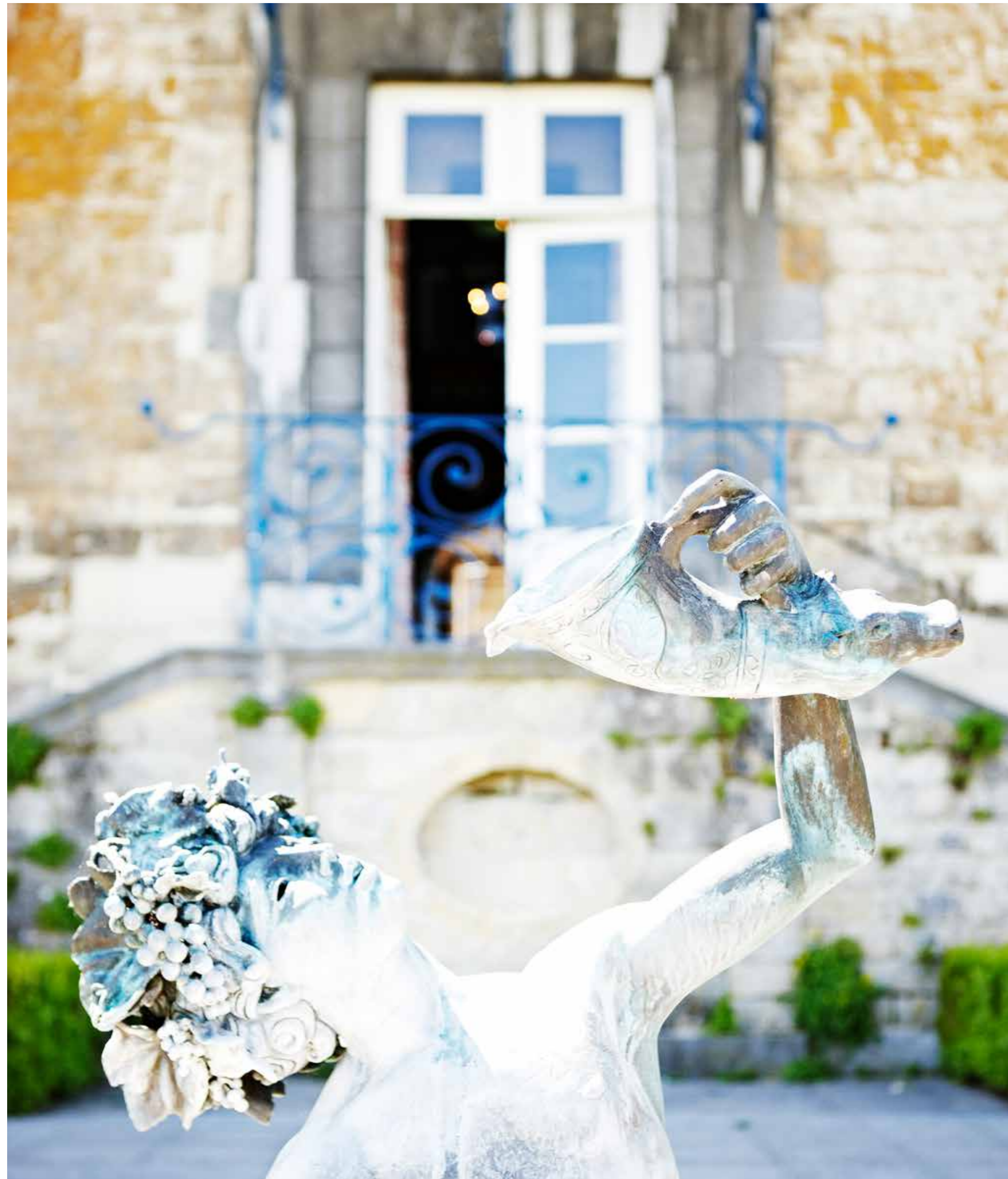



PODIUM OF SURPRISE

Het aan de rand van Maastricht gelegen Château Neercanne is het oudste terrassenkasteel van Nederland. Het chateau met weids uitzicht over het Jekerdal bevindt zich op de grens met België. Ruim zestig jaar geleden werd het gerestaureerd. In de afgelopen decennia is Château Neercanne uitgegroeid tot een instituut. Het restaurant heeft al dertig jaar een Michelinster. Lunchrestaurant l'Auberge, de in mergel gehouwen grotzalen, de wijngaard, de wijnkelders en het adembenemende terras maken deel uit van de setting waarbinnen bevlogen gastheren en cuisiniers de gast centraal stellen.

Located on the outskirts of Maastricht, Château Neercanne is the oldest terraced castle in the Netherlands. This castle, which has a panoramic view of the Jekerdal valley, is situated on the Belgian border. About sixty years ago it was fully restored and in the decades that have since passed, Château Neercanne has become an institute in the region. The restaurant has held a Michelin star for thirty years. Lunch restaurant l'Auberge, the cave halls carved in the marl hillside, the vineyard, wine cellars, and the breathtaking terrace create a setting where guests are fully catered to by enthusiastic hosts and chefs.





SINCERE QUALITY

Geen fratsen, grappen en grollen. Château Neercanne, onderdeel van Oostwegel Collection, is puur en echt. Het chateau biedt met respect voor het verleden dagelijks een thuis aan 120 gasten. Het tijdloze, ingetogen karakter van de doorware uit de Timeless-serie van FORMANI® sluit naadloos aan bij de kwaliteit en stabiliteit die leidend zijn binnen het kasteel.

No frills or antics: Château Neercanne, which is part of the Oostwegel Collection, is refined and authentic. The castle hosts 120 guests every day with an air of respect for its long and illustrious past. The timeless and unassuming character of the door fittings of the FORMANI@Timeless series seamlessly matches the quality and durability that are leading in the castle.



TIMELESS
1935MRR50 LEVER HANDLE SATIN NICKEL



TIMELESS
1935MPY LEVER HANDLE SATIN NICKEL

TIMELESS

RAAMBESLAG | WINDOW FITTINGS

RB-1923 massief raamboompje ten behoeve van naar buitendraaiend raam inclusief contraplaatje niet afsluitbaar | non-locking solid casement fastener for outward opening window including mortice plate



- mat nikkel/ebbenhout
satin nickel/ebony wood
- glans nikkel/ebbenhout
bright nickel/ebony wood

RB-1932 massief raamboompje ten behoeve van naar buitendraaiend raam inclusief contraplaatje niet afsluitbaar | non-locking solid casement fastener for outward opening window including mortice plate

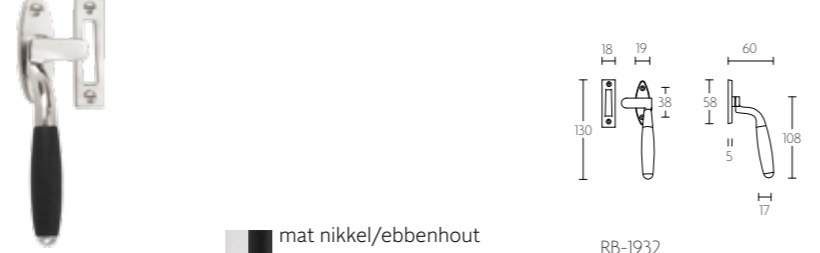

- mat nikkel/ebbenhout
satin nickel/ebony wood
- glans nikkel/ebbenhout
bright nickel/ebony wood
- messing ongelakt/ebbenhout
brass unlacquered/ebony wood

RB-1934 massief raamboompje ten behoeve van naar buitendraaiend raam inclusief contraplaatje niet afsluitbaar | non-locking solid casement fastener for outward opening window including mortice plate



- mat nikkel/ebbenhout
satin nickel/ebony wood
- glans nikkel/ebbenhout
bright nickel/ebony wood
- messing ongelakt/ebbenhout
brass unlacquered/ebony wood

RB-1938 massief raamboompje ten behoeve van naar buitendraaiend raam inclusief contraplaatje niet afsluitbaar | non-locking solid casement fastener for outward opening window including mortice plate



- mat nikkel
satin nickel
- glans nikkel
bright nickel
- messing ongelakt
brass unlacquered

RB-UNI massief raamboompje ten behoeve van naar buitendraaiend raam inclusief contraplaatje niet afsluitbaar | non-locking solid casement fastener for outward opening window including mortice plate

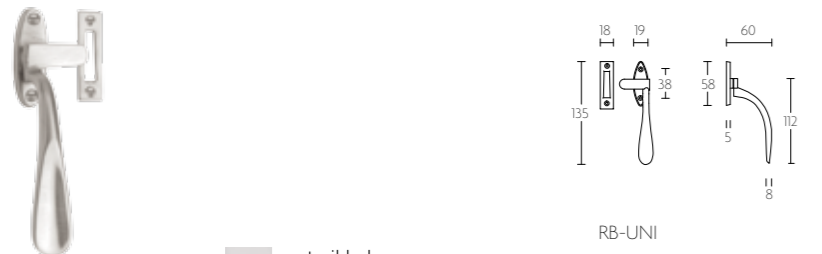

- mat nikkel
satin nickel
- glans nikkel
bright nickel
- messing ongelakt
brass unlacquered

HP-RBT losse haak ten behoeve van raamboompje voor naar binnendraaiend raam | separate hook plate for casement fastener for inward opening window



- mat nikkel
satin nickel
- glans nikkel
bright nickel
- messing ongelakt
brass unlacquered

TIMELESS

RAAMBESLAG | WINDOW FITTINGS

RBA-1923 afsluitbaar raamboompje voor naar buitendraaiend raam | locking solid casement fastener for outward opening window

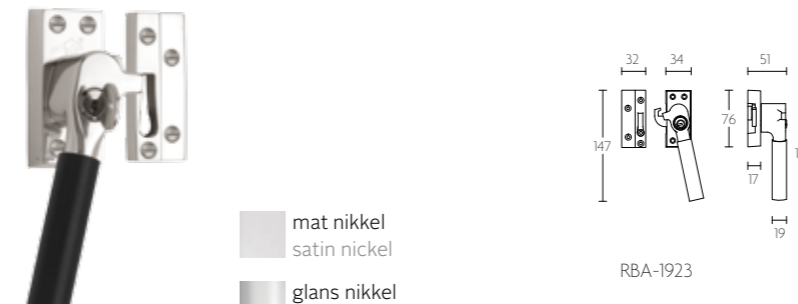

- mat nikkel
satin nickel
- glans nikkel
bright nickel
- mat nikkel/ebbenhout
satin nickel/ebony wood
- glans nikkel/ebbenhout
bright nickel/ebony wood

RBA-1932 afsluitbaar raamboompje voor naar buitendraaiend raam | locking solid casement fastener for outward opening window



- mat nikkel/ebbenhout
satin nickel/ebony wood
- glans nikkel/ebbenhout
bright nickel/ebony wood
- messing ongelakt/ebbenhout
brass unlacquered/ebony wood

RBA-1934 afsluitbaar raamboompje voor naar buitendraaiend raam | locking solid casement fastener for outward opening window



- mat nikkel/ebbenhout
satin nickel/ebony wood
- glans nikkel/ebbenhout
bright nickel/ebony wood
- messing ongelakt/ebbenhout
brass unlacquered/ebony wood

RBA-UNI afsluitbaar raamboompje voor naar buitendraaiend raam | locking solid casement fastener for outward opening window

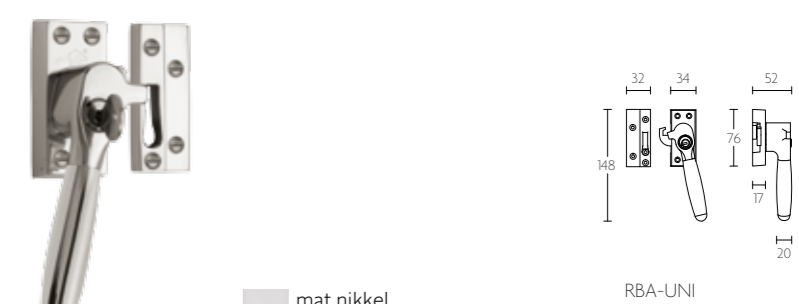

- mat nikkel
satin nickel
- glans nikkel
bright nickel
- messing ongelakt
brass unlacquered

RU-1923 massieve raamuitzetter met twee stelpennen inclusief geleiderail | solid casement stay with two pins including slide guide channel



- mat nikkel/ebbenhout
satin nickel/ebony wood
- glans nikkel/ebbenhout
bright nickel/ebony wood

RU-1932 massieve raamuitzetter met twee stelpennen inclusief geleiderail | solid casement stay with two pins including slide guide channel



- mat nikkel/ebbenhout
satin nickel/ebony wood
- glans nikkel/ebbenhout
bright nickel/ebony wood
- messing ongelakt/ebbenhout
brass unlacquered/ebony wood

TIMELESS

RAAMBESLAG | WINDOW FITTINGS

RU-1934

massieve raamuitzetter met twee stelpennen inclusief geleiderail | solid casement stay with two pins including slide guide channel



RU-1934

- mat nikkel/ebbenhout
satin nickel/ebony wood
- glans nikkel/ebbenhout
bright nickel/ebony wood
- messing ongelakt/ebbenhout
brass unlacquered/ebony wood

RU-1938

massieve raamuitzetter met twee stelpennen inclusief geleiderail | solid casement stay with two pins including slide guide channel



RU-1938

- mat nikkel
satin nickel
- glans nikkel
bright nickel
- messing ongelakt
brass unlacquered

RU-UNI

massieve raamuitzetter met twee stelpennen inclusief geleiderail | solid casement stay with two pins including slide guide channel



RU-UNI

- mat nikkel/ebbenhout
satin nickel/ebony wood
- glans nikkel/ebbenhout
bright nickel/ebony wood

1815-DK-O

draaikiepgarnituur niet afsluitbaar | non-locking tilt and turn window handle



1815-DK-O

- mat nikkel/ebbenhout
satin nickel/ebony wood
- glans nikkel/ebbenhout
bright nickel/ebony wood

1910L-DK-O

draaikiepgarnituur niet afsluitbaar | non-locking tilt and turn window handle



1910L-DK-O

- mat nikkel
satin nickel
- glans nikkel
bright nickel
- messing ongelakt
brass unlacquered

1910T-DK-O

draaikiepgarnituur niet afsluitbaar | non-locking tilt and turn window handle



1910T-DK-O

- mat nikkel
satin nickel
- glans nikkel
bright nickel
- messing ongelakt
brass unlacquered

1921-DK-O

draaikiepgarnituur niet afsluitbaar | non-locking tilt and turn window handle



1921-DK-O

- mat nikkel
satin nickel
- glans nikkel
bright nickel

1922-DK-O

draaikiepgarnituur niet afsluitbaar | non-locking tilt and turn window handle



1922-DK-O

- mat nikkel
satin nickel
- glans nikkel
bright nickel
- messing ongelakt
brass unlacquered

1923-DK-O

draaikiepgarnituur niet afsluitbaar | non-locking tilt and turn window handle

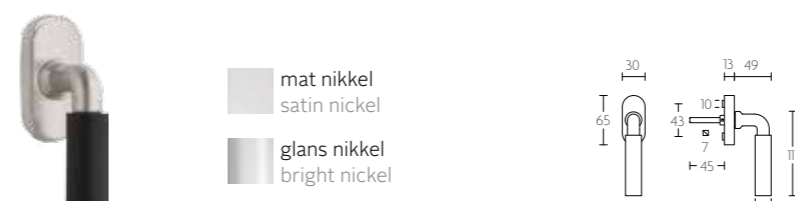

1923-DK-O

- mat nikkel
satin nickel
- glans nikkel
bright nickel
- messing ongelakt
brass unlacquered
- mat nikkel/ebbenhout
satin nickel/ebony wood
- glans nikkel/ebbenhout
bright nickel/ebony wood
- messing ongelakt/ebbenhout
brass unlacquered/ebony wood

1924-DK-O

draaikiepgarnituur niet afsluitbaar | non-locking tilt and turn window handle



1924-DK-O

- mat nikkel
satin nickel

1925-DK-O

draaikiepgarnituur niet afsluitbaar | non-locking tilt and turn window handle



1925-DK-O

- mat nikkel
satin nickel
- glans nikkel
bright nickel
- messing ongelakt
brass unlacquered

1927-DK-O

draaikiepgarnituur niet afsluitbaar | non-locking tilt and turn window handle



1927-DK-O

- mat nikkel
satin nickel
- glans nikkel
bright nickel
- messing ongelakt
brass unlacquered

TIMELESS

RAAMBESLAG | WINDOW FITTINGS

1929-DK-O draaikiëpgarnituur niet afsluitbaar | non-locking tilt and turn window handle



- mat nikkel
satin nickel
- glans nikkel
bright nickel
- messaging ongelakt
brass unlacquered

1930-DK-O draaikiëpgarnituur niet afsluitbaar | non-locking tilt and turn window handle

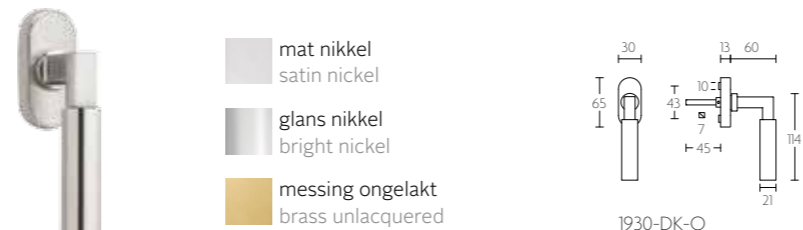

- mat nikkel
satin nickel
- glans nikkel
bright nickel
- messaging ongelakt
brass unlacquered
- mat nikkel/ebbenhout
satin nickel/ebony wood
- glans nikkel/ebbenhout
bright nickel/ebony wood
- messaging ongelakt/ebbenhout
brass unlacquered/ebony wood

1935-DK-O draaikiëpgarnituur niet afsluitbaar | non-locking tilt and turn window handle



- mat nikkel
satin nickel
- glans nikkel
bright nickel
- messaging ongelakt
brass unlacquered

1938-DK-O draaikiëpgarnituur niet afsluitbaar | non-locking tilt and turn window handle



- mat nikkel
satin nickel
- glans nikkel
bright nickel
- messaging ongelakt
brass unlacquered

1931-DK-O draaikiëpgarnituur niet afsluitbaar | non-locking tilt and turn window handle



- mat nikkel/ebbenhout
satin nickel/ebony wood
- glans nikkel/ebbenhout
bright nickel/ebony wood
- messaging ongelakt/ebbenhout
brass unlacquered/ebony wood

1932-DK-O draaikiëpgarnituur niet afsluitbaar | non-locking tilt and turn window handle



- mat nikkel/ebbenhout
satin nickel/ebony wood
- glans nikkel/ebbenhout
bright nickel/ebony wood
- messaging ongelakt/ebbenhout
brass unlacquered/ebony wood

1939-DK-O draaikiëpgarnituur niet afsluitbaar | non-locking tilt and turn window handle



- mat nikkel
satin nickel
- glans nikkel
bright nickel

1940-DK-O draaikiëpgarnituur niet afsluitbaar | non-locking tilt and turn window handle



- mat nikkel
satin nickel
- glans nikkel
bright nickel

1932T-DK-O draaikiëpgarnituur niet afsluitbaar | non-locking tilt and turn window handle



- mat nikkel/ebbenhout
satin nickel/ebony wood
- glans nikkel/ebbenhout
bright nickel/ebony wood
- messaging ongelakt/ebbenhout
brass unlacquered/ebony wood

1934-DK-O draaikiëpgarnituur niet afsluitbaar | non-locking tilt and turn window handle



- mat nikkel/ebbenhout
satin nickel/ebony wood
- glans nikkel/ebbenhout
bright nickel/ebony wood
- messaging ongelakt/ebbenhout
brass unlacquered/ebony wood

1946-DK-O draaikiëpgarnituur niet afsluitbaar | non-locking tilt and turn window handle



- mat nikkel
satin nickel
- glans nikkel
bright nickel
- messaging ongelakt
brass unlacquered

1948-DK-O draaikiëpgarnituur niet afsluitbaar | non-locking tilt and turn window handle



- mat nikkel
satin nickel
- glans nikkel
bright nickel
- messaging ongelakt
brass unlacquered

TIMELESS

RAAMBESLAG | WINDOW FITTINGS

1952-DK-O draaikiëpgarnituur niet afsluitbaar | non-locking tilt and turn window handle

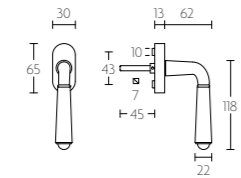
1952-DK-O

- mat nikkel/ebbenhout
satin nickel/ebony wood
- glans nikkel/ebbenhout
bright nickel/ebony wood

1923-DK-A draaikiëpgarnituur afsluitbaar | locking tilt and turn window handle

1923-DK-A

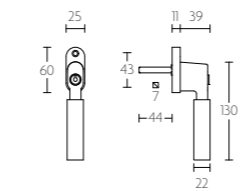
- mat nikkel
satin nickel
- glans nikkel
bright nickel
- messing ongelakt
brass unlacquered
- mat nikkel/ebbenhout
satin nickel/ebony wood
- glans nikkel/ebbenhout
bright nickel/ebony wood
- messing ongelakt/ebbenhout
brass unlacquered/ebony wood

1932-DK-FA draaikiëpgarnituur afsluitbaar | locking tilt and turn window handle

1932-DK-FA

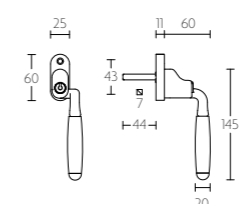
- mat nikkel/ebbenhout
satin nickel/ebony wood
- glans nikkel/ebbenhout
bright nickel/ebony wood
- messing ongelakt/ebbenhout
brass unlacquered/ebony wood

1934-DK-FA draaikiëpgarnituur afsluitbaar | locking tilt and turn window handle

1934-DK-FA

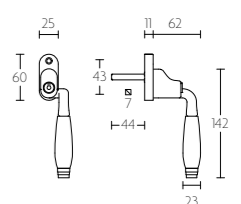
- mat nikkel/ebbenhout
satin nickel/ebony wood
- glans nikkel/ebbenhout
bright nickel/ebony wood
- messing ongelakt/ebbenhout
brass unlacquered/ebony wood

1932-DK-A draaikiëpgarnituur afsluitbaar | locking tilt and turn window handle



1932-DK-A

- mat nikkel/ebbenhout
satin nickel/ebony wood
- glans nikkel/ebbenhout
bright nickel/ebony wood
- messing ongelakt/ebbenhout
brass unlacquered/ebony wood

1934-DK-A draaikiëpgarnituur afsluitbaar | locking tilt and turn window handle



1934-DK-A

- mat nikkel/ebbenhout
satin nickel/ebony wood
- glans nikkel/ebbenhout
bright nickel/ebony wood
- messing ongelakt/ebbenhout
brass unlacquered/ebony wood

1952-DK-FA draaikiëpgarnituur afsluitbaar | locking tilt and turn window handle



1952-DK-FA

- mat nikkel/ebbenhout
satin nickel/ebony wood
- glans nikkel/ebbenhout
bright nickel/ebony wood
- messing ongelakt/ebbenhout
brass unlacquered/ebony wood

1815-DKLOCK-O draaikiëpgarnituur afsluitbaar | locking tilt and turn window handle



1815-DKLOCK-O

- mat nikkel/ebbenhout
satin nickel/ebony wood
- glans nikkel/ebbenhout
bright nickel/ebony wood

1952-DK-A draaikiëpgarnituur afsluitbaar | locking tilt and turn window handle

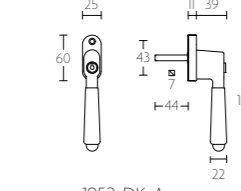
1952-DK-A

- mat nikkel/ebbenhout
satin nickel/ebony wood
- glans nikkel/ebbenhout
bright nickel/ebony wood
- messing ongelakt/ebbenhout
brass unlacquered/ebony wood

1923-DK-FA draaikiëpgarnituur afsluitbaar | locking tilt and turn window handle

1923-DK-FA

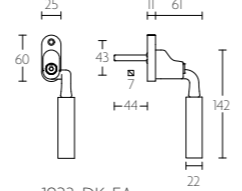
- mat nikkel
satin nickel
- glans nikkel
bright nickel
- messing ongelakt
brass unlacquered
- mat nikkel/ebbenhout
satin nickel/ebony wood
- glans nikkel/ebbenhout
bright nickel/ebony wood
- messing ongelakt/ebbenhout
brass unlacquered/ebony wood

1910L-DKLOCK-O draaikiëpgarnituur afsluitbaar | locking tilt and turn window handle

1910L-DKLOCK-O

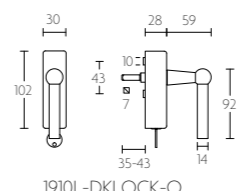
- mat nikkel
satin nickel
- glans nikkel
bright nickel
- messing ongelakt
brass unlacquered

1910T-DKLOCK-O draaikiëpgarnituur afsluitbaar | locking tilt and turn window handle

1910T-DKLOCK-O

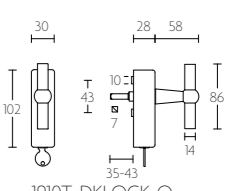
- mat nikkel
satin nickel
- glans nikkel
bright nickel
- messing ongelakt
brass unlacquered

TIMELESS

RAAMBESLAG | WINDOW FITTINGS

1921-DKLOCK-O draaikepgarnituur afsluitbaar | locking tilt and turn window handle



- mat nikkel
satin nickel
- glans nikkel
bright nickel

1922-DKLOCK-O draaikepgarnituur afsluitbaar | locking tilt and turn window handle



- mat nikkel
satin nickel
- glans nikkel
bright nickel
- messing ongelakt
brass unlacquered

1929-DKLOCK-O draaikepgarnituur afsluitbaar | locking tilt and turn window handle



- mat nikkel
satin nickel
- glans nikkel
bright nickel
- messing ongelakt
brass unlacquered

1930-DKLOCK-O draaikepgarnituur afsluitbaar | locking tilt and turn window handle

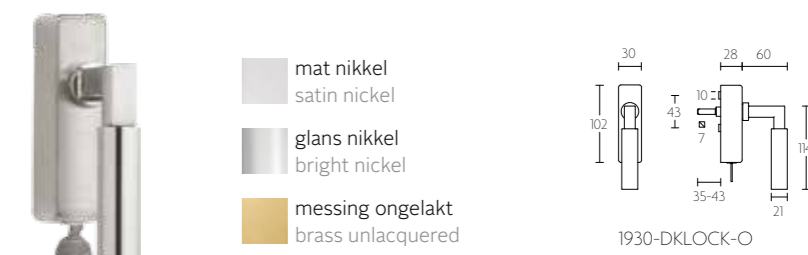

- mat nikkel
satin nickel
- glans nikkel
bright nickel
- messing ongelakt
brass unlacquered
- mat nikkel/ebbenhout
satin nickel/ebony wood
- glans nikkel/ebbenhout
bright nickel/ebony wood
- messing ongelakt/ebbenhout
brass unlacquered/ebony wood

1923-DKLOCK-O draaikepgarnituur afsluitbaar | locking tilt and turn window handle

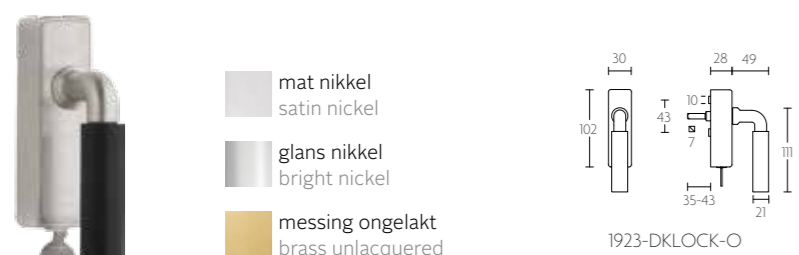

- mat nikkel
satin nickel
- glans nikkel
bright nickel
- messing ongelakt
brass unlacquered
- mat nikkel/ebbenhout
satin nickel/ebony wood
- glans nikkel/ebbenhout
bright nickel/ebony wood
- messing ongelakt/ebbenhout
brass unlacquered/ebony wood

1924-DKLOCK-O draaikepgarnituur afsluitbaar | locking tilt and turn window handle



- mat nikkel
satin nickel

1931-DKLOCK-O draaikepgarnituur afsluitbaar | locking tilt and turn window handle



- mat nikkel/ebbenhout
satin nickel/ebony wood
- glans nikkel/ebbenhout
bright nickel/ebony wood
- messing ongelakt/ebbenhout
brass unlacquered/ebony wood

1932-DKLOCK-O draaikepgarnituur afsluitbaar | locking tilt and turn window handle



- mat nikkel/ebbenhout
satin nickel/ebony wood
- glans nikkel/ebbenhout
bright nickel/ebony wood
- messing ongelakt/ebbenhout
brass unlacquered/ebony wood

1925-DKLOCK-O draaikepgarnituur afsluitbaar | locking tilt and turn window handle



- mat nikkel
satin nickel
- glans nikkel
bright nickel
- messing ongelakt
brass unlacquered

1927-DKLOCK-O draaikepgarnituur afsluitbaar | locking tilt and turn window handle



- mat nikkel
satin nickel
- glans nikkel
bright nickel
- messing ongelakt
brass unlacquered

1932T-DKLOCK-O draaikepgarnituur afsluitbaar | locking tilt and turn window handle



- mat nikkel/ebbenhout
satin nickel/ebony wood
- glans nikkel/ebbenhout
bright nickel/ebony wood
- messing ongelakt/ebbenhout
brass unlacquered/ebony wood

1934-DKLOCK-O draaikepgarnituur afsluitbaar | locking tilt and turn window handle



- mat nikkel/ebbenhout
satin nickel/ebony wood
- glans nikkel/ebbenhout
bright nickel/ebony wood
- messing ongelakt/ebbenhout
brass unlacquered/ebony wood

TIMELESS

RAAMBESLAG | WINDOW FITTINGS

TIMELESS

RAAMBESLAG | WINDOW FITTINGS

1935-DKLOCK-O draaikiëpgarnituur afsluitbaar | locking tilt and turn window handle

mat nikkel
satin nickel

glans nikkel
bright nickel

messing ongelakt
brass unlacquered

1935-DKLOCK-O

1938-DKLOCK-O draaikiëpgarnituur afsluitbaar | locking tilt and turn window handle

mat nikkel
satin nickel

glans nikkel
bright nickel

messing ongelakt
brass unlacquered

1938-DKLOCK-O

1939-DKLOCK-O draaikiëpgarnituur afsluitbaar | locking tilt and turn window handle

mat nikkel
satin nickel

glans nikkel
bright nickel

1939-DKLOCK-O

1940-DKLOCK-O draaikiëpgarnituur afsluitbaar | locking tilt and turn window handle

mat nikkel
satin nickel

glans nikkel
bright nickel

1940-DKLOCK-O

1946-DKLOCK-O draaikiëpgarnituur afsluitbaar | locking tilt and turn window handle

mat nikkel
satin nickel

glans nikkel
bright nickel

messing ongelakt
brass unlacquered

1946-DKLOCK-O

1948-DKLOCK-O draaikiëpgarnituur afsluitbaar | locking tilt and turn window handle

mat nikkel
satin nickel

glans nikkel
bright nickel

messing ongelakt
brass unlacquered

1948-DKLOCK-O

1952-DKLOCK-O draaikiëpgarnituur afsluitbaar | locking tilt and turn window handle

mat nikkel/ebenhout
satin nickel/ebony wood

glans nikkel/ebenhout
bright nickel/ebony wood

1952-DKLOCK-O

KO-1910T krukespagolet inclusief vier geleiders, twee eindstukjes en twee stangen standaard geschikt tot 2900mm | espagnolette bolt with top and bottom receiver plate, two rods and four rod guides standard to suit 2900mm

mat nikkel
satin nickel

glans nikkel
bright nickel

messing ongelakt
brass unlacquered

KO-1910T

KO-1922 krukespagolet inclusief vier geleiders, twee eindstukjes en twee stangen standaard geschikt tot 2900mm | espagnolette bolt with top and bottom receiver plate, two rods and four rod guides standard to suit 2900mm

mat nikkel
satin nickel

glans nikkel
bright nickel

messing ongelakt
brass unlacquered

KO-1922

TIMELESS

RAAMBESLAG | WINDOW FITTINGS

KO-1910L krukespagolet inclusief vier geleiders, twee eindstukjes en twee stangen standaard geschikt tot 2900mm | espagnolette bolt with top and bottom receiver plate, two rods and four rod guides standard to suit 2900mm

mat nikkel
satin nickel

glans nikkel
bright nickel

messing ongelakt
brass unlacquered

KO-1910L

KO-1921 krukespagolet inclusief vier geleiders, twee eindstukjes en twee stangen standaard geschikt tot 2900mm | espagnolette bolt with top and bottom receiver plate, two rods and four rod guides standard to suit 2900mm

mat nikkel
satin nickel

glans nikkel
bright nickel

KO-1921

KO-1923 krukespagolet inclusief vier geleiders, twee eindstukjes en twee stangen standaard geschikt tot 2900mm | espagnolette bolt with top and bottom receiver plate, two rods and four rod guides standard to suit 2900mm

mat nikkel
satin nickel

glans nikkel
bright nickel

messing ongelakt
brass unlacquered

mat nikkel/ebenhout
satin nickel/ebony wood

glans nikkel/ebenhout
bright nickel/ebony wood

messing ongelakt/ebenhout
brass unlacquered/ebony wood

KO-1923

KO-1924

krukespagolet inclusief vier geleiders, twee eindstukjes en twee stangen
standaard geschikt tot 2900mm

espagnolette bolt with top and bottom receiver plate, two rods and four rod guides
standard to suit 2900mm



mat nikkel
satin nickel

KO-1924

KO-1925

krukespagolet inclusief vier geleiders, twee eindstukjes en twee stangen
standaard geschikt tot 2900mm

espagnolette bolt with top and bottom receiver plate, two rods and four rod guides
standard to suit 2900mm



mat nikkel
satin nickel

glans nikkel
bright nickel

messing ongelakt
brass unlacquered

KO-1925

KO-1932

krukespagolet inclusief vier geleiders, twee eindstukjes en twee stangen
standaard geschikt tot 2900mm

espagnolette bolt with top and bottom receiver plate, two rods and four rod guides
standard to suit 2900mm

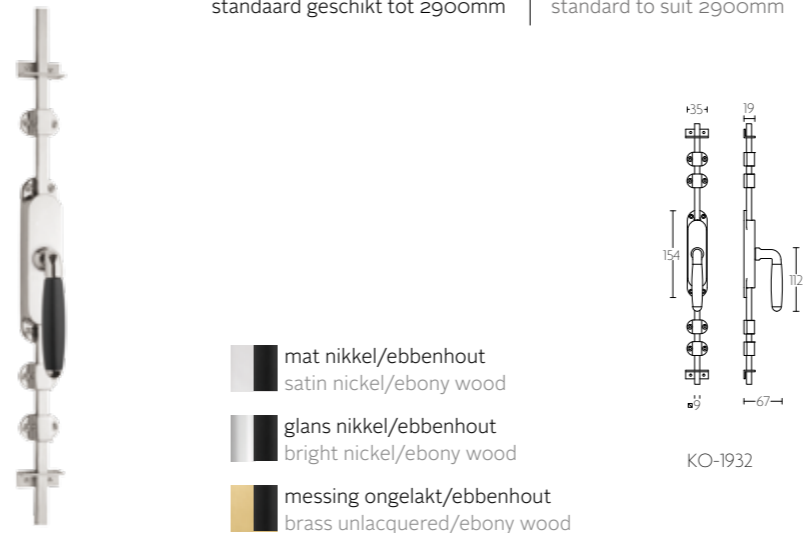

mat nikkel/ebenhout
satin nickel/ebony wood

glans nikkel/ebenhout
bright nickel/ebony wood

messing ongelakt/ebenhout
brass unlacquered/ebony wood

KO-1932

KO-1932T

krukespagolet inclusief vier geleiders, twee eindstukjes en twee stangen
standaard geschikt tot 2900mm

espagnolette bolt with top and bottom receiver plate, two rods and four rod guides
standard to suit 2900mm

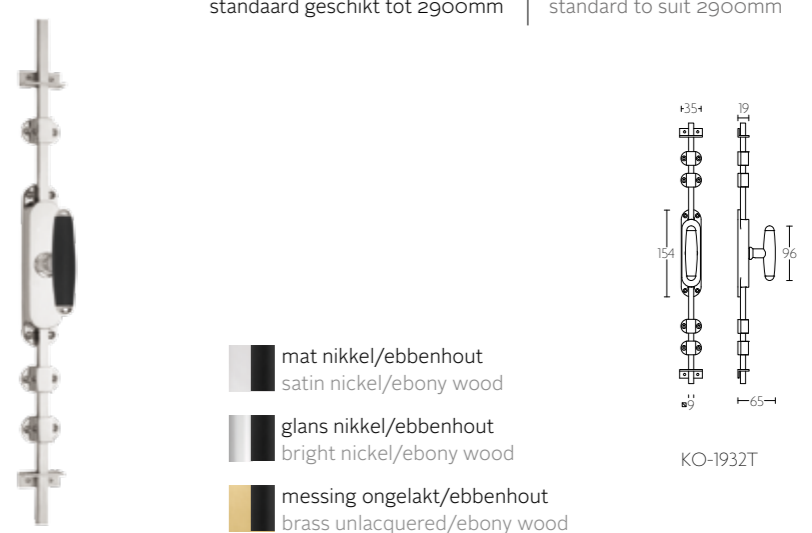

mat nikkel/ebenhout
satin nickel/ebony wood

glans nikkel/ebenhout
bright nickel/ebony wood

messing ongelakt/ebenhout
brass unlacquered/ebony wood

KO-1932T

KO-1927

krukespagolet inclusief vier geleiders, twee eindstukjes en twee stangen
standaard geschikt tot 2900mm

espagnolette bolt with top and bottom receiver plate, two rods and four rod guides
standard to suit 2900mm

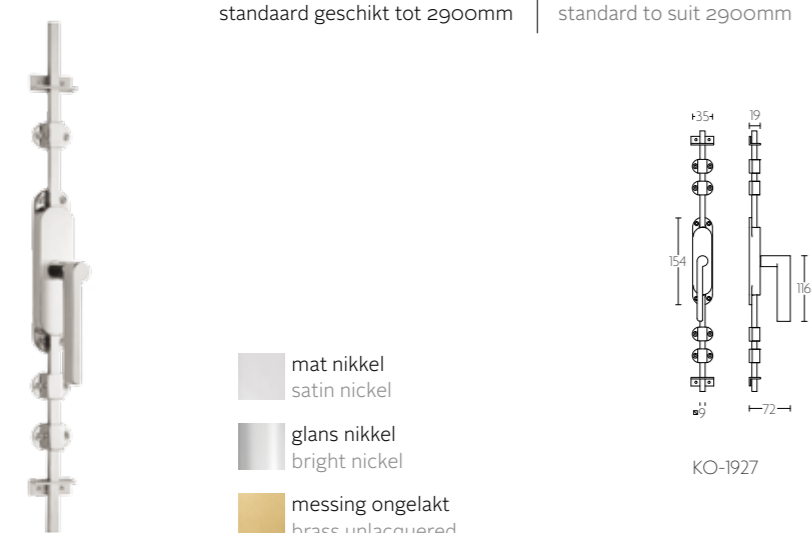

mat nikkel
satin nickel

glans nikkel
bright nickel

messing ongelakt
brass unlacquered

KO-1927

KO-1929

krukespagolet inclusief vier geleiders, twee eindstukjes en twee stangen
standaard geschikt tot 2900mm

espagnolette bolt with top and bottom receiver plate, two rods and four rod guides
standard to suit 2900mm

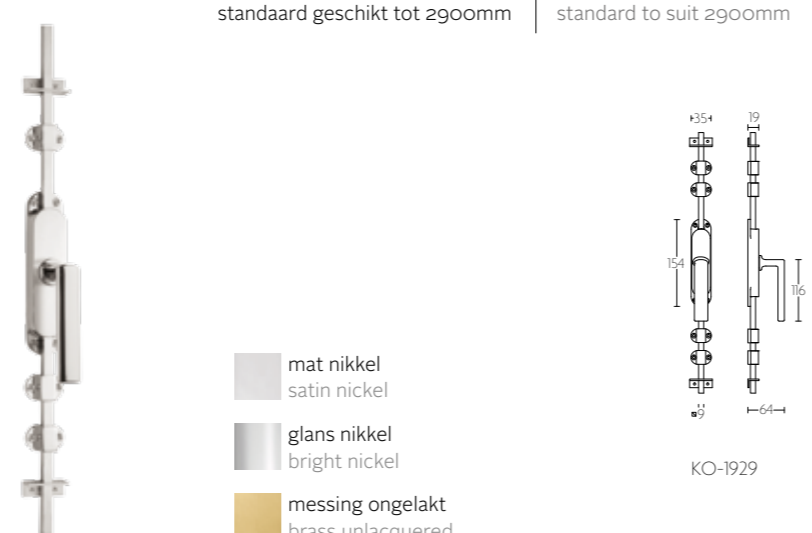

mat nikkel
satin nickel

glans nikkel
bright nickel

messing ongelakt
brass unlacquered

KO-1929

KO-1934

krukespagolet inclusief vier geleiders, twee eindstukjes en twee stangen
standaard geschikt tot 2900mm

espagnolette bolt with top and bottom receiver plate, two rods and four rod guides
standard to suit 2900mm

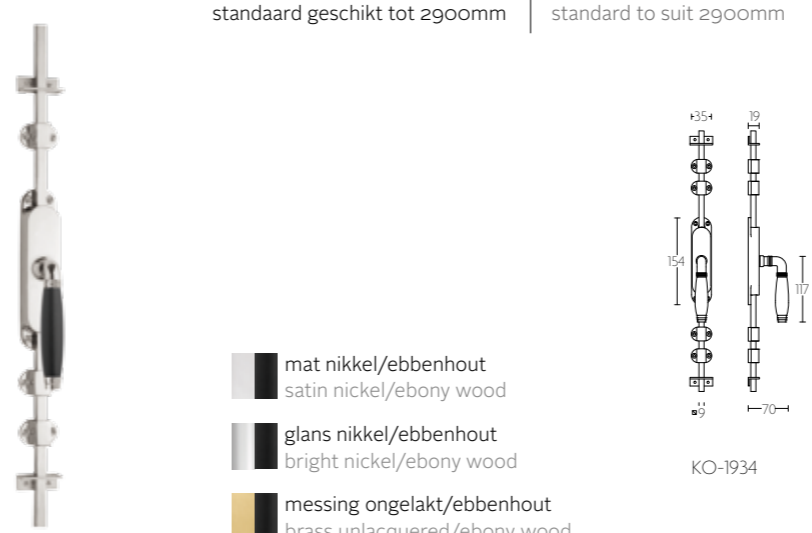

mat nikkel/ebenhout
satin nickel/ebony wood

glans nikkel/ebenhout
bright nickel/ebony wood

messing ongelakt/ebenhout
brass unlacquered/ebony wood

KO-1934

KO-1935

krukespagolet inclusief vier geleiders, twee eindstukjes en twee stangen
standaard geschikt tot 2900mm

espagnolette bolt with top and bottom receiver plate, two rods and four rod guides
standard to suit 2900mm

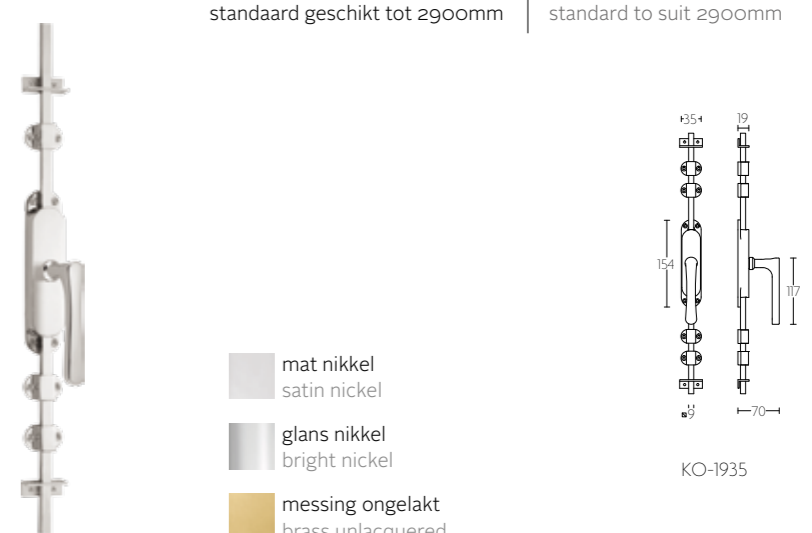

mat nikkel
satin nickel

glans nikkel
bright nickel

messing ongelakt
brass unlacquered

KO-1935

KO-1930

krukespagolet inclusief vier geleiders, twee eindstukjes en twee stangen
standaard geschikt tot 2900mm

espagnolette bolt with top and bottom receiver plate, two rods and four rod guides
standard to suit 2900mm

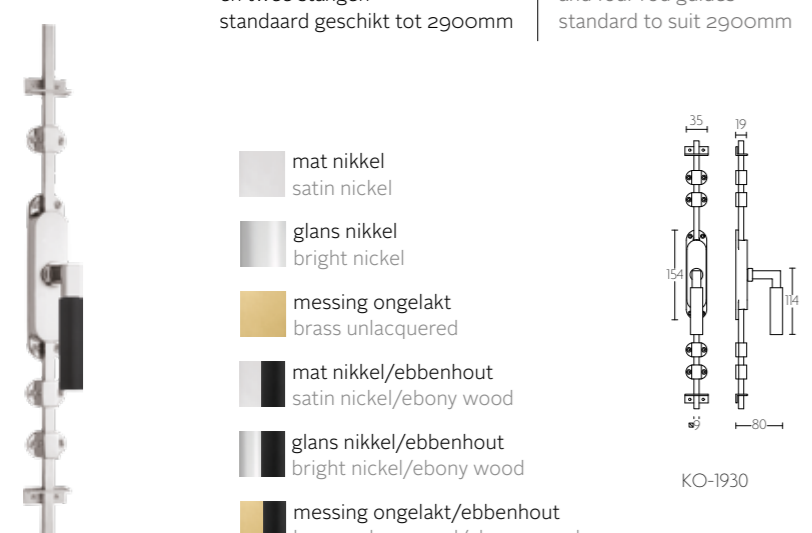

mat nikkel
satin nickel

glans nikkel
bright nickel

messing ongelakt
brass unlacquered

mat nikkel/ebenhout
satin nickel/ebony wood

glans nikkel/ebenhout
bright nickel/ebony wood

messing ongelakt/ebenhout
brass unlacquered/ebony wood

KO-1930

KO-1931

krukespagolet inclusief vier geleiders, twee eindstukjes en twee stangen
standaard geschikt tot 2900mm

espagnolette bolt with top and bottom receiver plate, two rods and four rod guides
standard to suit 2900mm

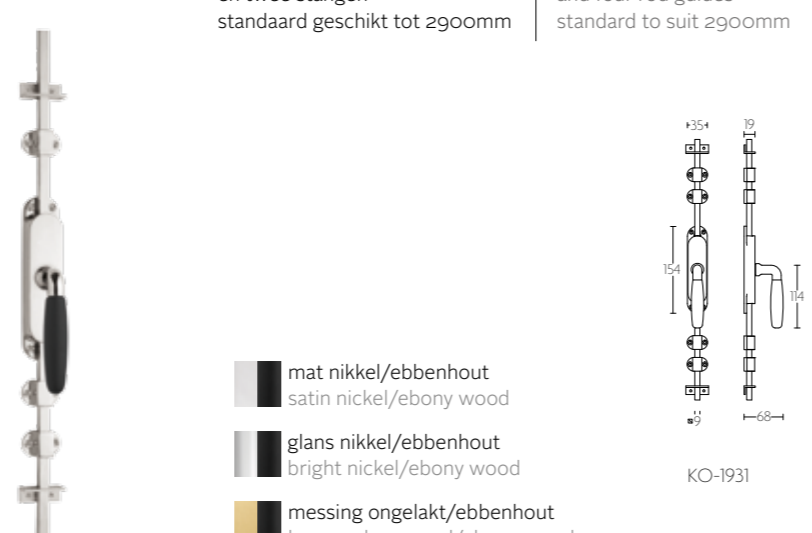

mat nikkel/ebenhout
satin nickel/ebony wood

glans nikkel/ebenhout
bright nickel/ebony wood

messing ongelakt/ebenhout
brass unlacquered/ebony wood

KO-1931

KO-1938

krukespagolet inclusief vier geleiders, twee eindstukjes en twee stangen
standaard geschikt tot 2900mm

espagnolette bolt with top and bottom receiver plate, two rods and four rod guides
standard to suit 2900mm

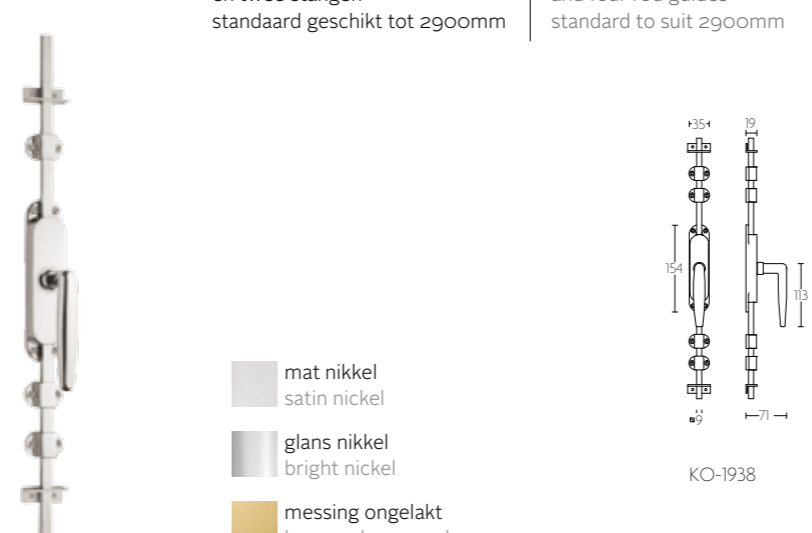

mat nikkel
satin nickel

glans nikkel
bright nickel

messing ongelakt
brass unlacquered

KO-1938

KO-1939

krukespagolet inclusief vier geleiders, twee eindstukjes en twee stangen
standaard geschikt tot 2900mm

espagnolette bolt with top and bottom receiver plate, two rods and four rod guides
standard to suit 2900mm

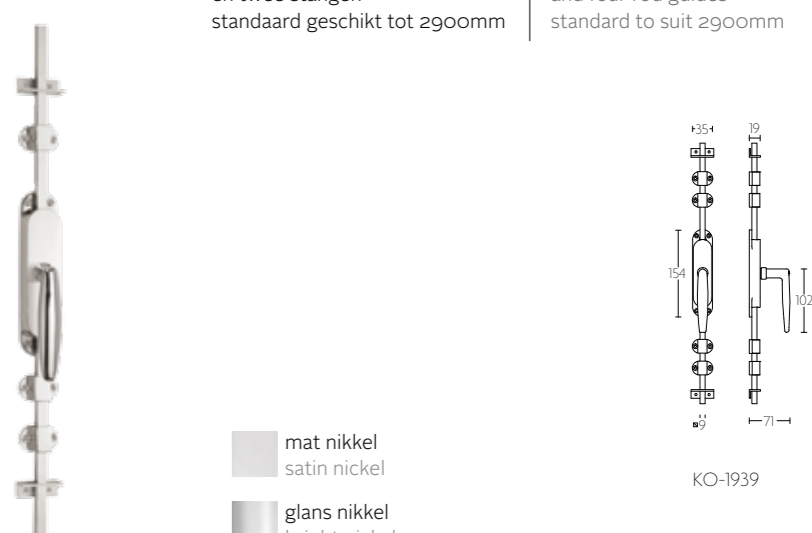

mat nikkel
satin nickel

glans nikkel
bright nickel

KO-1939

KO-1940

krukespagolet inclusief vier geleiders, twee eindstukjes en twee stangen
standaard geschikt tot 2900mm

espagnolette bolt with top and bottom receiver plate, two rods and four rod guides
standard to suit 2900mm

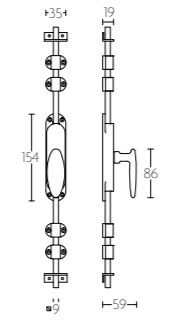
mat nikkel
satin nickel

glans nikkel
bright nickel

KO-1940

KO-1946

krukespagolet inclusief vier geleiders, twee eindstukjes en twee stangen
standaard geschikt tot 2900mm

espagnolette bolt with top and bottom receiver plate, two rods and four rod guides
standard to suit 2900mm

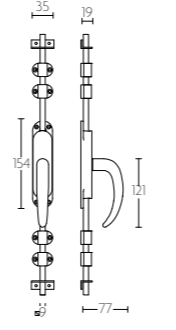
mat nikkel
satin nickel

glans nikkel
bright nickel

messing ongelakt
brass unlacquered

KO-1946

KO-1948

krukespagolet inclusief vier geleiders, twee eindstukjes en twee stangen
standaard geschikt tot 2900mm

espagnolette bolt with top and bottom receiver plate, two rods and four rod guides
standard to suit 2900mm

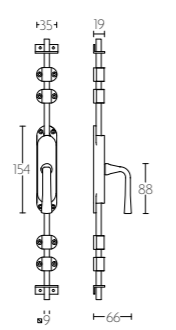
mat nikkel
satin nickel

glans nikkel
bright nickel

messing ongelakt
brass unlacquered

KO-1948

KO-1952

krukespagolet inclusief vier geleiders, twee eindstukjes en twee stangen
standaard geschikt tot 2900mm

espagnolette bolt with top and bottom receiver plate, two rods and four rod guides
standard to suit 2900mm

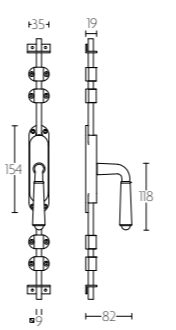
mat nikkel/ebenhout
satin nickel/ebony wood

glans nikkel/ebenhout
bright nickel/ebony wood

KO-1952

P-1923

pompespagolet inclusief drie geleiders, twee eindstukjes en twee stangen
standaard geschikt tot 2900mm

espagnolette bolt with top and bottom receiver plate, two rods and three rod guides
standard to suit 2900mm

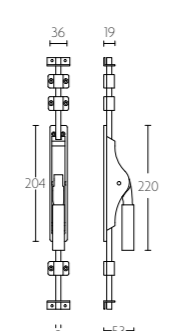
mat nikkel
satin nickel

glans nikkel
bright nickel

messing ongelakt
brass unlacquered

mat nikkel/ebenhout
satin nickel/ebony wood

glans nikkel/ebenhout
bright nickel/ebony wood

messing ongelakt/ebenhout
brass unlacquered/ebony wood

P-1923

P-1925

pompespagolet inclusief drie geleiders, twee eindstukjes en twee stangen
standaard geschikt tot 2900mm

espagnolette bolt with top and bottom receiver plate, two rods and three rod guides
standard to suit 2900mm

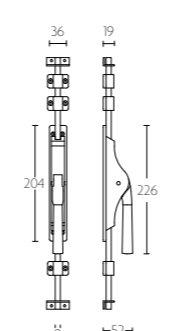
mat nikkel
satin nickel

glans nikkel
bright nickel

messing ongelakt
brass unlacquered

P-1925

P-1931

pompespagolet inclusief drie geleiders, twee eindstukjes en twee stangen
standaard geschikt tot 2900mm

espagnolette bolt with top and bottom receiver plate, two rods and three rod guides
standard to suit 2900mm

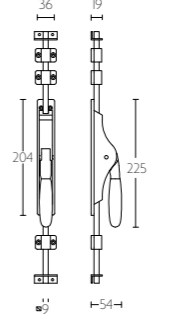
mat nikkel/ebenhout
satin nickel/ebony wood

glans nikkel/ebenhout
bright nickel/ebony wood

messing ongelakt/ebenhout
brass unlacquered/ebony wood

P-1931

P-1932

pompespagolet inclusief drie geleiders, twee eindstukjes en twee stangen
standaard geschikt tot 2900mm

espagnolette bolt with top and bottom receiver plate, two rods and three rod guides
standard to suit 2900mm

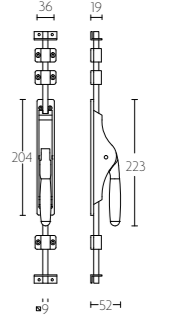
mat nikkel/ebenhout
satin nickel/ebony wood

glans nikkel/ebenhout
bright nickel/ebony wood

messing ongelakt/ebenhout
brass unlacquered/ebony wood

P-1932

P-1934

pompespagolet inclusief drie geleiders, twee eindstukjes en twee stangen
standaard geschikt tot 2900mm

espagnolette bolt with top and bottom receiver plate, two rods and three rod guides
standard to suit 2900mm

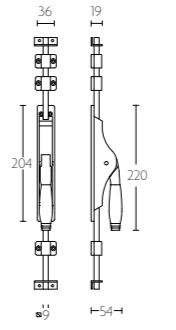
mat nikkel/ebenhout
satin nickel/ebony wood

glans nikkel/ebenhout
bright nickel/ebony wood

messing ongelakt/ebenhout
brass unlacquered/ebony wood

P-1934

P-1952

pompespagolet inclusief drie geleiders, twee eindstukjes en twee stangen
standaard geschikt tot 2900mm

espagnolette bolt with top and bottom receiver plate, two rods and three rod guides
standard to suit 2900mm

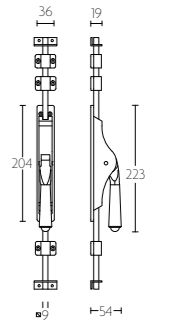
mat nikkel/ebenhout
satin nickel/ebony wood

glans nikkel/ebenhout
bright nickel/ebony wood

P-1952

E-LOCK9

slot ten behoeve van espagnoletstang 9mm
lock for espagnolette rod 9mm

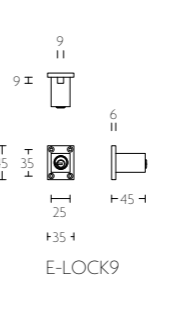
mat nikkel
satin nickel

glans nikkel
bright nickel

messing ongelakt
brass unlacquered

E-LOCK9

MG1923B

massieve raamgreep | solid window handle

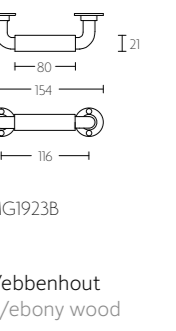
mat nikkel
satin nickel

glans nikkel
bright nickel

messing ongelakt
brass unlacquered

mat nikkel/ebenhout
satin nickel/ebony wood

glans nikkel/ebenhout
bright nickel/ebony wood

messing ongelakt/ebenhout
brass unlacquered/ebony wood

MG1923B

TIMELESS

RAAMBESLAG | WINDOW FITTINGS

MG1930B massieve raamgreep | solid window handle

MG1930B

- mat nikkel / satin nickel
- glans nikkel / bright nickel
- messing ongelakt / brass unlacquered
- mat nikkel/ebenhout / satin nickel/ebony wood
- glans nikkel/ebenhout / bright nickel/ebony wood
- messing ongelakt/ebenhout / brass unlacquered/ebony wood

MG1932C massieve raamgreep | solid window handle

MG1932C

- mat nikkel/ebenhout / satin nickel/ebony wood
- glans nikkel/ebenhout / bright nickel/ebony wood
- messing ongelakt/ebenhout / brass unlacquered/ebony wood

MG1934C massieve raamgreep | solid window handle

MG1934C

- mat nikkel/ebenhout / satin nickel/ebony wood
- glans nikkel/ebenhout / bright nickel/ebony wood
- messing ongelakt/ebenhout / brass unlacquered/ebony wood

PA707 massieve raamgreep | solid window handle

PA707A

PA707B

- mat nikkel / satin nickel

PA752 massieve raamgreep | solid window handle

PA752A

PA752B

- mat nikkel / satin nickel

TIMELESS

VOORDEURBESLAG | FRONT DOOR FITTINGS

CD55V voordeurknop vast op rozet | front door knob fixed on rose

CD55V

- PVD mat nikkel / PVD satin nickel

F507 massieve voordeurknop vast op rozet | solid front door knob fixed on rose

F507

- PVD mat nikkel / PVD satin nickel
- PVD glans nikkel / PVD bright nickel
- messing ongelakt / brass unlacquered

F788A voordeurknop vast op rozet | front door knob fixed on rose

F788A

- PVD mat nikkel / PVD satin nickel
- messing ongelakt / brass unlacquered

F788B voordeurknop vast op rozet | front door knob fixed on rose

F788B

- PVD mat nikkel / PVD satin nickel
- messing ongelakt / brass unlacquered

F788C voordeurknop vast op rozet | front door knob fixed on rose

F788C

- PVD mat nikkel / PVD satin nickel
- messing ongelakt / brass unlacquered

LSQ60V massieve voordeurknop vast op rozet | solid front door knob fixed on rose

LSQ60V

- PVD mat nikkel / PVD satin nickel
- PVD glans nikkel / PVD bright nickel
- messing ongelakt / brass unlacquered

TIMELESS

VOORDEURBESLAG | FRONT DOOR FITTINGS

LBVEIL massieve veiligheidscilinderrozet | solid security escutcheons

PVD mat nikkel
 PVD satijn nikkel
 PVD mat nikkel/mat nikkel
 PVD satijn nikkel/satijn nikkel
 PVD glans nikkel/glans nikkel
 PVD helder nikkel/helder nikkel

LBVEIL-KT massieve veiligheidscilinderrozet met kerntrekbeveiliging | solid security escutcheons with cylinder protection cover

PVD mat nikkel
 PVD satijn nikkel
 PVD mat nikkel/mat nikkel
 PVD satijn nikkel/satijn nikkel
 PVD glans nikkel/glans nikkel
 PVD helder nikkel/helder nikkel

SVEIL massieve veiligheidscilinderrozet | solid security escutcheons

PVD mat nikkel
 PVD satijn nikkel
 PVD mat nikkel/mat nikkel
 PVD satijn nikkel/satijn nikkel
 PVD glans nikkel/glans nikkel
 PVD helder nikkel/helder nikkel
 messing ongelakt
 brass unlacquered

LSQVEIL-B massieve veiligheidscilinderrozet | solid security escutcheons

PVD mat nikkel
 PVD satijn nikkel
 PVD mat nikkel/mat nikkel
 PVD satijn nikkel/satijn nikkel
 PVD glans nikkel/glans nikkel
 PVD helder nikkel/helder nikkel

LSQVEIL-BKT massieve veiligheidscilinderrozet met kerntrekbeveiliging | solid security escutcheons with cylinder protection cover

PVD mat nikkel
 PVD satijn nikkel
 PVD mat nikkel/mat nikkel
 PVD satijn nikkel/satijn nikkel
 PVD glans nikkel/glans nikkel
 PVD helder nikkel/helder nikkel

LSQVEIL-C massieve veiligheidscilinderrozet | solid security escutcheons

PVD mat nikkel
 PVD satijn nikkel
 PVD mat nikkel/mat nikkel
 PVD satijn nikkel/satijn nikkel
 PVD glans nikkel/glans nikkel
 PVD helder nikkel/helder nikkel

LSQVEIL-CKT massieve veiligheidscilinderrozet met kerntrekbeveiliging | solid security escutcheons with cylinder protection cover

PVD mat nikkel
 PVD satijn nikkel
 PVD mat nikkel/mat nikkel
 PVD satijn nikkel/satijn nikkel
 PVD glans nikkel/glans nikkel
 PVD helder nikkel/helder nikkel

LB507-50 massieve veiligheidsschilden met vaste knop ten behoeve van deurkruk | solid security plates with fixed knob to suit lever handle

PVD mat nikkel/mat nikkel
 PVD satijn nikkel/satijn nikkel
 PVD glans nikkel/glans nikkel
 PVD helder nikkel/helder nikkel

LB507-50KT massieve veiligheidsschilden met vaste knop, ten behoeve van deurkruk met kerntrekbeveiliging | solid security plates with fixed knob to suit lever handle with cylinder protection cover

PVD mat nikkel/mat nikkel
 PVD satijn nikkel/satijn nikkel
 PVD glans nikkel/glans nikkel
 PVD helder nikkel/helder nikkel

LB60-50 massieve veiligheidsschilden met vaste knop ten behoeve van deurkruk | solid security plates with fixed knob to suit lever handle

PVD mat nikkel/mat nikkel
 PVD satijn nikkel/satijn nikkel
 PVD glans nikkel/glans nikkel
 PVD helder nikkel/helder nikkel

LB60-50KT massieve veiligheidsschilden met vaste knop, ten behoeve van deurkruk met kerntrekbeveiliging | solid security plates with fixed knob to suit lever handle with cylinder protection cover

PVD mat nikkel/mat nikkel
 PVD satijn nikkel/satijn nikkel
 PVD glans nikkel/glans nikkel
 PVD helder nikkel/helder nikkel

LBSM-50 massieve veiligheidsschilden ten behoeve van deurkrukken | solid security plates to suit lever handles

PVD mat nikkel/mat nikkel
 PVD satijn nikkel/satijn nikkel
 PVD glans nikkel/glans nikkel
 PVD helder nikkel/helder nikkel



SPAIN BARCELONA

LOCATION: BARCELONA, SPAIN
OBJECT: HOTEL DO
INTERIOR DESIGN: LAZARO ROSA-VIOLAN STUDIO
PHOTOGRAPHY: TYCHO MERJUN ROEST



TIMELESS
1934-DK-O TILT AND TURN WINDOW HANDLE BRIGHT NICKEL / EBONY WOOD



FORMANI®
TIMELESS



TIMELESS
MG1934C PULL HANDLE BRIGHT NICKEL / EBONY WOOD

THE BARRI GÒTIC

Op het Plaça Reial, het meest bekende en karakteristieke plein van Barcelona, ligt hotel DO; een 5 sterren gastronomisch boetiekhotel dat in 2013 volledig werd gerenoveerd door Lázaro Rosa-Violán studio. Eén van FORMANI's meest gelauwerde concepten, Timeless serie 1934, werd door het hele hotel, in alle achttien luxe kamers, conceptmatig toegepast.

On Plaça Reial, one of Barcelona's best-known and most charming squares, stands Hotel DO – a 5* gastronomic boutique hotel that was completely renovated by Lázaro Rosa-Violán studio in 2013. One of FORMANI's most celebrated design ideas, the Timeless series 1934, saw itself used as an overall concept to adorn each of the hotel's eighteen luxury rooms.



TIMELESS
1934-DK-O TILT AND TURN WINDOW HANDLE
BRIGHT NICKEL / EBONY WOOD

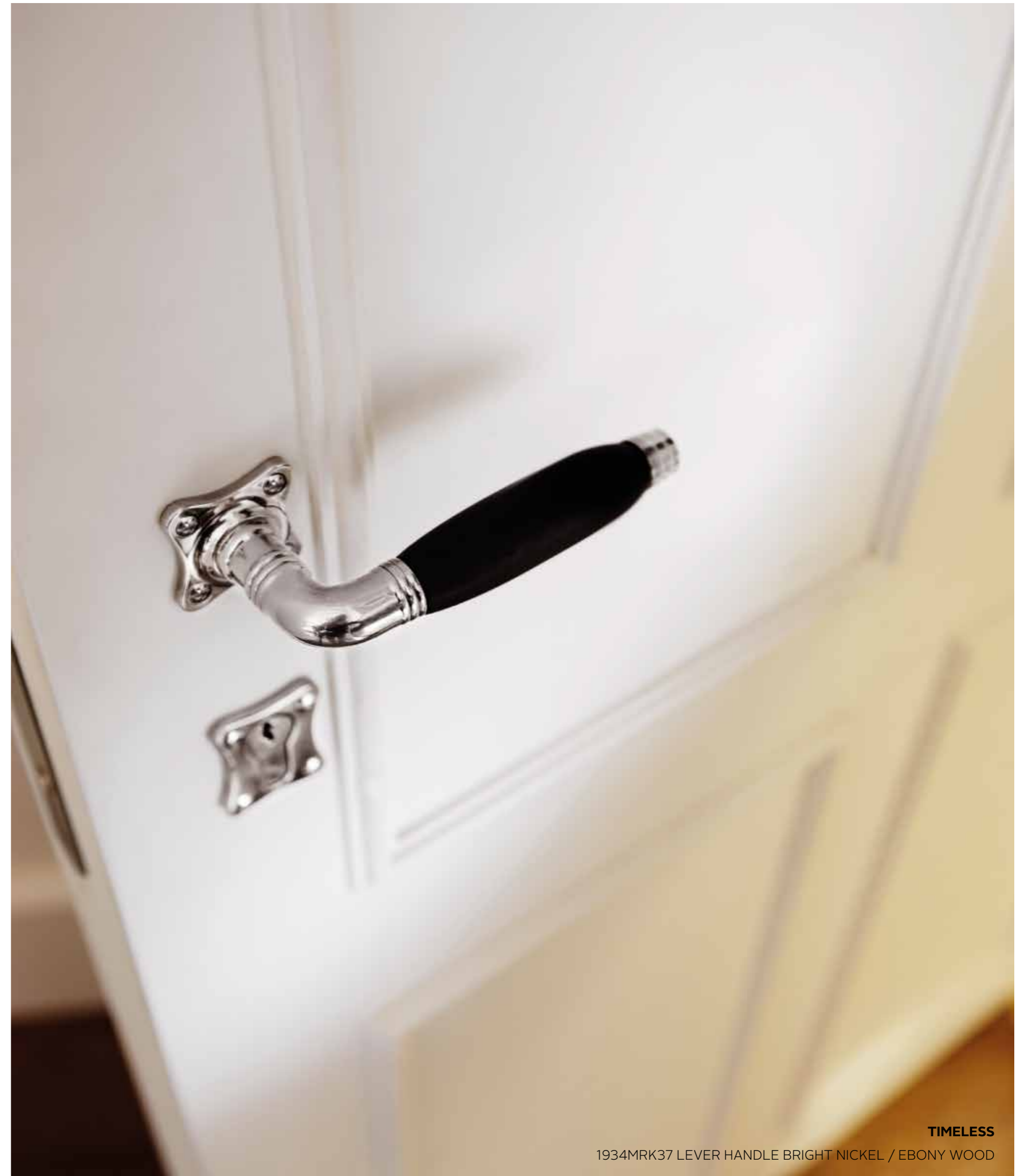

TIMELESS
1934MRK37 LEVER HANDLE BRIGHT NICKEL / EBONY WOOD

TIMELESS

VOORDEURBESLAG | FRONT DOOR FITTINGS

LBSM-50KT massieve veiligheidsschilden ten behoeve van deurkrukken met kerntrekbeveiliging solid security plates to suit lever handles with cylinder protection cover

PVD mat nikkel / mat nikkel
 PVD satin nikkel / satin nikkel
 PVD glans nikkel / glans nikkel
 PVD bright nikkel / bright nikkel
 messing ongelakt / brass unlacquered

LBSM-50KT * afstand opgeven bij bestelling
* state distance on order

F535 massieve buitenbriefplaat solid letter plate

PVD mat nikkel / PVD satin nikkel
 PVD glans nikkel / PVD bright nikkel
 messing ongelakt / brass unlacquered

F535BI massieve tochtborstel solid internal tidy

mat nikkel / satin nikkel
 glans nikkel / bright nikkel
 messing ongelakt / brass unlacquered

F510 bedrukker met verchromd drukkertje bell push with chrome plated bell button

PVD mat nikkel / PVD satin nikkel
 messing ongelakt / brass unlacquered

F511 bedrukker met verchromd drukkertje bell push with chrome plated bell button

PVD mat nikkel / PVD satin nikkel
 PVD glans nikkel / PVD bright nikkel
 messing ongelakt / brass unlacquered

F515 bedrukker met verchromd drukkertje bell push with chrome plated bell button

PVD mat nikkel / PVD satin nikkel
 messing ongelakt / brass unlacquered

TIMELESS

VOORDEURBESLAG | FRONT DOOR FITTINGS

LSQ65 massieve bedrukker met roestvast stalen drukkertje solid bell push with stainless steel bell button

PVD mat nikkel / PVD satin nikkel
 PVD glans nikkel / PVD bright nikkel
 messing ongelakt / brass unlacquered

HN80-0 huisnummer 0 numeral 0

PVD mat nikkel / PVD satin nikkel
 PVD glans nikkel / PVD bright nikkel
 messing ongelakt / brass unlacquered

HN80-1 huisnummer 1 numeral 1

PVD mat nikkel / PVD satin nikkel
 PVD glans nikkel / PVD bright nikkel
 messing ongelakt / brass unlacquered

HN80-2 huisnummer 2 numeral 2

PVD mat nikkel / PVD satin nikkel
 PVD glans nikkel / PVD bright nikkel
 messing ongelakt / brass unlacquered

HN80-3 huisnummer 3 numeral 3

PVD mat nikkel / PVD satin nikkel
 PVD glans nikkel / PVD bright nikkel
 messing ongelakt / brass unlacquered

HN80-4 huisnummer 4 numeral 4

PVD mat nikkel / PVD satin nikkel
 PVD glans nikkel / PVD bright nikkel
 messing ongelakt / brass unlacquered

TIMELESS

VOORDEURBESLAG | FRONT DOOR FITTINGS

HN80-5 huisnummer 5 | numeral 5

HN80-5

- PVD mat nikkel / PVD satin nickel
- PVD glans nikkel / PVD bright nickel
- messing ongelakt / brass unlacquered

HN80-6/9 huisnummer 6/9 | numeral 6/9

HN80-6

- PVD mat nikkel / PVD satin nickel
- PVD glans nikkel / PVD bright nickel
- messing ongelakt / brass unlacquered

HN80-7 huisnummer 7 | numeral 7

HN80-7

- PVD mat nikkel / PVD satin nickel
- PVD glans nikkel / PVD bright nickel
- messing ongelakt / brass unlacquered

HN80-8 huisnummer 8 | numeral 8

HN80-8

- PVD mat nikkel / PVD satin nickel
- PVD glans nikkel / PVD bright nickel
- messing ongelakt / brass unlacquered

HN80-9/6 huisnummer 9/6 | numeral 9/6

HN80-9

- PVD mat nikkel / PVD satin nickel
- PVD glans nikkel / PVD bright nickel
- messing ongelakt / brass unlacquered

TIMELESS

ACCESSOIRES | ACCESSORIES

MG1910L massieve greep / solid pull handle
tbv houten deuren / for timber doors

MG1910L

- mat nikkel / satin nickel
- glans nikkel / bright nickel
- messing ongelakt / brass unlacquered

MG1910T massieve greep / solid pull handle
tbv houten deuren / for timber doors

MG1910T

- mat nikkel / satin nickel
- glans nikkel / bright nickel
- messing ongelakt / brass unlacquered

MG1923A massieve greep / solid pull handle
tbv houten deuren / for timber doors

MG1923A

- mat nikkel / satin nickel
- glans nikkel / bright nickel
- messing ongelakt / brass unlacquered
- mat nikkel/ebbenhout / satin nickel/ebony wood
- glans nikkel/ebbenhout / bright nickel/ebony wood
- messing ongelakt/ebbenhout / brass unlacquered/ebony wood

MG1923B massieve greep / solid pull handle
tbv houten deuren / for timber doors

MG1923B

- mat nikkel / satin nickel
- glans nikkel / bright nickel
- messing ongelakt / brass unlacquered
- mat nikkel/ebbenhout / satin nickel/ebony wood
- glans nikkel/ebbenhout / bright nickel/ebony wood
- messing ongelakt/ebbenhout / brass unlacquered/ebony wood

MG1929 massieve greep / solid pull handle
tbv houten deuren / for timber doors

MG1929

- mat nikkel / satin nickel
- glans nikkel / bright nickel
- messing ongelakt / brass unlacquered

MG1930A massieve greep / solid pull handle
tbv houten deuren / for timber doors

MG1930A

- mat nikkel / satin nickel
- glans nikkel / bright nickel
- messing ongelakt / brass unlacquered
- mat nikkel/ebbenhout / satin nickel/ebony wood
- glans nikkel/ebbenhout / bright nickel/ebony wood
- messing ongelakt/ebbenhout / brass unlacquered/ebony wood

TIMELESS

ACCESSOIRES | ACCESSORIES

MG1930B massieve greep
tbv houten deuren | solid pull handle
for timber doors



- mat nikkel
satin nickel
- glans nikkel
bright nickel
- messing ongelakt
brass unlacquered
- mat nikkel/ebbenhout
satin nickel/ebony wood
- glans nikkel/ebbenhout
bright nickel/ebony wood
- messing ongelakt/ebbenhout
brass unlacquered/ebony wood

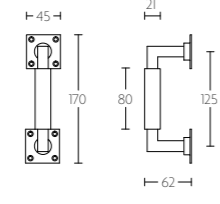

MG1930B

MG1932A massieve greep
tbv houten deuren | solid pull handle
for timber doors

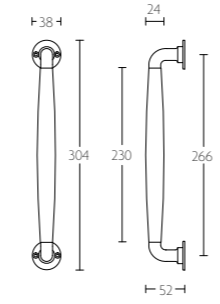
- mat nikkel/ebbenhout
satin nickel/ebony wood
- glans nikkel/ebbenhout
bright nickel/ebony wood
- messing ongelakt/ebbenhout
brass unlacquered/ebony wood

MG1932A

MG1932B massieve greep
tbv houten deuren | solid pull handle
for timber doors

- mat nikkel/ebbenhout
satin nickel/ebony wood
- glans nikkel/ebbenhout
bright nickel/ebony wood
- messing ongelakt/ebbenhout
brass unlacquered/ebony wood

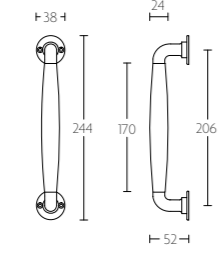
MG1932B

MG1932C massieve greep
tbv houten deuren | solid pull handle
for timber doors

- mat nikkel/ebbenhout
satin nickel/ebony wood
- glans nikkel/ebbenhout
bright nickel/ebony wood
- messing ongelakt/ebbenhout
brass unlacquered/ebony wood

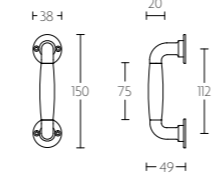
MG1932C

MG1934C massieve greep
tbv houten deuren | solid pull handle
for timber doors



- mat nikkel/ebbenhout
satin nickel/ebony wood
- glans nikkel/ebbenhout
bright nickel/ebony wood
- messing ongelakt/ebbenhout
brass unlacquered/ebony wood

MG1934C

MG1938 massieve greep
tbv houten deuren | solid pull handle
for timber doors

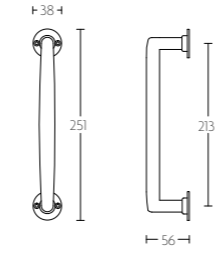
- mat nikkel
satin nickel
- glans nikkel
bright nickel
- messing ongelakt
brass unlacquered

MG1938

TIMELESS

ACCESSOIRES | ACCESSORIES

LB57S set inbouwkomen te verlijmen
inclusief 6mm stift
(exclusief slot) | set of flush pulls for glue fitting
including 6mm spindle
(lock not included)



- mat nikkel
satin nickel
- glans nikkel
bright nickel
- messing ongelakt
brass unlacquered

LB57S

LB57 inbouwkom
te verlijmen | flush pull
for glue fitting

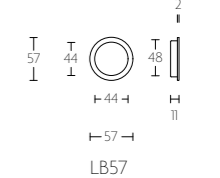
- mat nikkel
satin nickel
- glans nikkel
bright nickel
- messing ongelakt
brass unlacquered

LB57

LB29 fingertip kopse kant deur
ter verlijmen | fingertip edge fitting
for glue fitting

- mat nikkel
satin nickel
- glans nikkel
bright nickel
- messing ongelakt
brass unlacquered

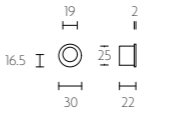
LB29

F780 inbouwkom | flush pull

- mat nikkel
satin nickel
- glans nikkel
bright nickel
- messing ongelakt
brass unlacquered

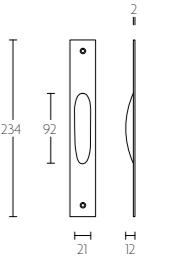
F780

MN1031
by Jo Coenen inbouwkom
te verlijmen | flush pull
for glue fitting



- mat nikkel
satin nickel

MN1031

MN926 inbouwkom
te verlijmen | flush pull
for glue fitting



- mat nikkel
satin nickel

MN926

TIMELESS

ACCESSOIRES | ACCESSORIES

MN800/32 inbouwkom te verlijmen | flush pull for glue fitting



MN800/32

mat nikkel
satin nickel

MN800/128 inbouwkom te verlijmen | flush pull for glue fitting



MN800/128

mat nikkel
satin nickel

MG1910/96 massieve meubelgreep | solid cabinet handle

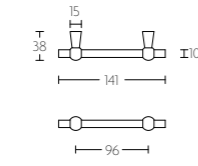
MG1910/96

mat nikkel
satin nickel

glans nikkel
bright nickel

messing ongelakt
brass unlacquered

MG1910/128 massieve meubelgreep | solid cabinet handle

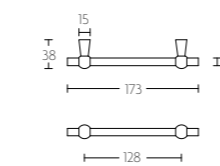
MG1910/128

mat nikkel
satin nickel

glans nikkel
bright nickel

messing ongelakt
brass unlacquered

MG1910/160 massieve meubelgreep | solid cabinet handle

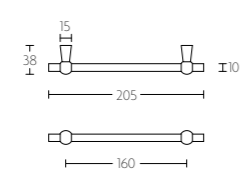
MG1910/160

mat nikkel
satin nickel

glans nikkel
bright nickel

messing ongelakt
brass unlacquered

MG1910/192 massieve meubelgreep | solid cabinet handle

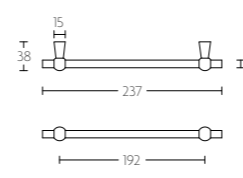
MG1910/192

mat nikkel
satin nickel



glans nikkel
bright nickel

messing ongelakt
brass unlacquered

TIMELESS

ACCESSOIRES | ACCESSORIES

MG1910/224 massieve meubelgreep | solid cabinet handle

MG1910/224

mat nikkel
satin nickel

glans nikkel
bright nickel

messing ongelakt
brass unlacquered

MG1923/96 massieve meubelgreep | solid cabinet handle





MG1923/96

mat nikkel/ebenhout
satin nickel/ebony wood

glans nikkel/ebenhout
bright nickel/ebony wood

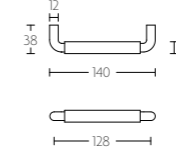
MG1923/128 massieve meubelgreep | solid cabinet handle





MG1923/128

mat nikkel/ebenhout
satin nickel/ebony wood

glans nikkel/ebenhout
bright nickel/ebony wood

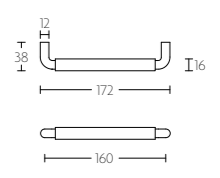
MG1923/160 massieve meubelgreep | solid cabinet handle





MG1923/160

mat nikkel/ebenhout
satin nickel/ebony wood

glans nikkel/ebenhout
bright nickel/ebony wood

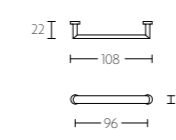
MG1929/96 massieve meubelgreep | solid cabinet handle

MG1929/96

mat nikkel
satin nickel

glans nikkel
bright nickel

messing ongelakt
brass unlacquered

mat zwart
satin black

MG1929/128 massieve meubelgreep | solid cabinet handle

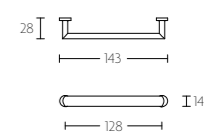
MG1929/128

mat nikkel
satin nickel

glans nikkel
bright nickel

messing ongelakt
brass unlacquered

mat zwart
satin black

TIMELESS

ACCESSOIRES | ACCESSORIES

MG1930/96 massieve meubelgreep | solid cabinet handle



mat nikkel/ebbenhout
 satin nikkel/ebony wood
 glans nikkel/ebbenhout
 bright nikkel/ebony wood
 messing ongelakt/ebbenhout
 brass unlacquered/ebony wood

MG1930/96

MG1930/128 massieve meubelgreep | solid cabinet handle



mat nikkel/ebbenhout
 satin nikkel/ebony wood
 glans nikkel/ebbenhout
 bright nikkel/ebony wood
 messing ongelakt/ebbenhout
 brass unlacquered/ebony wood

MG1930/128

MG1934/96 massieve meubelgreep | solid cabinet handle



mat nikkel/ebbenhout
 satin nikkel/ebony wood
 glans nikkel/ebbenhout
 bright nikkel/ebony wood
 messing ongelakt/ebbenhout
 brass unlacquered/ebony wood

MG1934/96

MG1934/128 massieve meubelgreep | solid cabinet handle



mat nikkel/ebbenhout
 satin nikkel/ebony wood
 glans nikkel/ebbenhout
 bright nikkel/ebony wood
 messing ongelakt/ebbenhout
 brass unlacquered/ebony wood

MG1934/128

MG1930/160 massieve meubelgreep | solid cabinet handle



mat nikkel/ebbenhout
 satin nikkel/ebony wood
 glans nikkel/ebbenhout
 bright nikkel/ebony wood
 messing ongelakt/ebbenhout
 brass unlacquered/ebony wood

MG1930/160

MG1932/96 massieve meubelgreep | solid cabinet handle



mat nikkel/ebbenhout
 satin nikkel/ebony wood
 glans nikkel/ebbenhout
 bright nikkel/ebony wood
 messing ongelakt/ebbenhout
 brass unlacquered/ebony wood

MG1932/96

MG1934/160 massieve meubelgreep | solid cabinet handle



mat nikkel/ebbenhout
 satin nikkel/ebony wood
 glans nikkel/ebbenhout
 bright nikkel/ebony wood
 messing ongelakt/ebbenhout
 brass unlacquered/ebony wood

MG1934/160

MG1938/96 massieve meubelgreep | solid cabinet handle



mat nikkel
 satin nikkel
 messing ongelakt
 brass unlacquered
 glans nikkel
 bright nikkel
 mat zwart
 satin black

MG1938/96

MG1932/128 massieve meubelgreep | solid cabinet handle



mat nikkel/ebbenhout
 satin nikkel/ebony wood
 glans nikkel/ebbenhout
 bright nikkel/ebony wood
 messing ongelakt/ebbenhout
 brass unlacquered/ebony wood

MG1932/128

MG1932/160 massieve meubelgreep | solid cabinet handle



mat nikkel/ebbenhout
 satin nikkel/ebony wood
 glans nikkel/ebbenhout
 bright nikkel/ebony wood
 messing ongelakt/ebbenhout
 brass unlacquered/ebony wood

MG1932/160

MG1938/128 massieve meubelgreep | solid cabinet handle



mat nikkel
 satin nikkel
 messing ongelakt
 brass unlacquered
 glans nikkel
 bright nikkel
 mat zwart
 satin black

MG1938/128

1910M massieve meubelknop | solid cabinet knob



mat nikkel
 satin nikkel
 glans nikkel
 bright nikkel
 messing ongelakt
 brass unlacquered

1910M

TIMELESS

ACCESSOIRES | ACCESSORIES

1929M massieve meubelknop | solid cabinet knob



1929M

- mat nikkel / satin nickel
- glans nikkel / bright nickel
- messing ongelakt / brass unlacquered
- mat zwart / satin black

1932M massieve meubelknop | solid cabinet knob

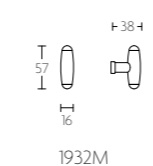
1932M

- mat nikkel/ebbenhout / satin nickel/ebony wood
- glans nikkel/ebbenhout / bright nickel/ebony wood
- messing ongelakt/ebbenhout / brass unlacquered/ebony wood

1934M massieve meubelknop | solid cabinet knob

1934M

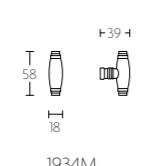
- mat nikkel/ebbenhout / satin nickel/ebony wood
- glans nikkel/ebbenhout / bright nickel/ebony wood
- messing ongelakt/ebbenhout / brass unlacquered/ebony wood

1938M massieve meubelknop | solid cabinet knob

1938M

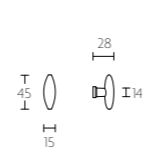
- mat nikkel / satin nickel
- glans nikkel / bright nickel
- messing ongelakt / brass unlacquered
- mat zwart / satin black

MKK40 massieve (meterkast)knop | solid cabinet knob

MKK40

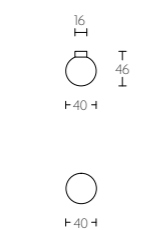
- mat nikkel / satin nickel
- glans nikkel / bright nickel
- messing ongelakt / brass unlacquered

MRK/50 massieve (meterkast)knop vast op rozet | solid cabinet knob fixed on rose

MRK/50

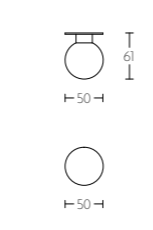
- mat nikkel / satin nickel
- glans nikkel / bright nickel
- messing ongelakt / brass unlacquered

TIMELESS

ACCESSOIRES | ACCESSORIES

MPK massieve (meterkast)knop vast op schild | solid cabinet knob fixed on plate

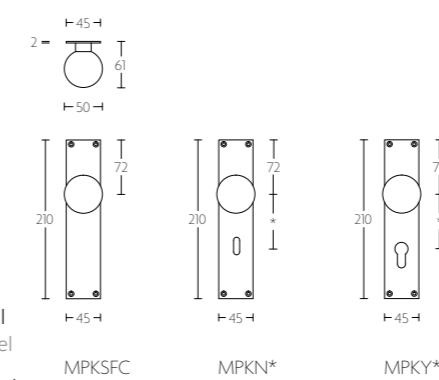
MPKSFC MPKN* MPKY*

- mat nikkel / satin nickel
- glans nikkel / bright nickel
- messing ongelakt / brass unlacquered

* afstand opgeven bij bestelling
* state distance on order

MRKG/50 massieve glasdeurknoppen vast op rozet ten behoeve van glazen deur | solid door knobs on rose for glass door



MRKG/50

- mat nikkel / satin nickel
- glans nikkel / bright nickel
- messing ongelakt / brass unlacquered

F540 deurstop vloer en wand | door stop floor and wall mounted





F540

- mat nikkel / satin nickel
- glans nikkel / bright nickel
- messing ongelakt / brass unlacquered

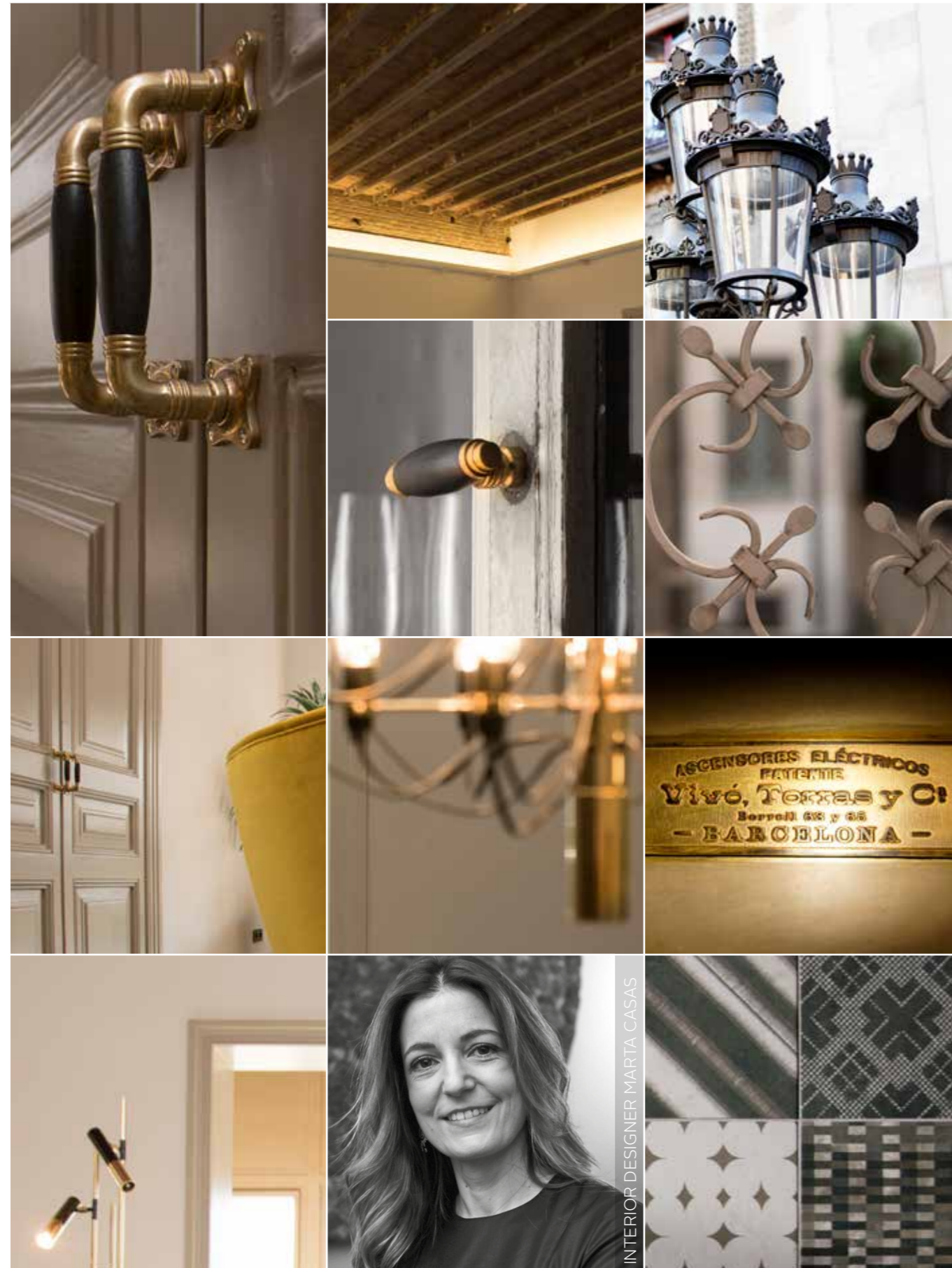

SPAIN BARCELONA

LOCATION: BARCELONA, SPAIN
OBJECT: HISTORICAL CITY OFFICES
INTERIOR DESIGN: MARTA CASAS
PHOTOGRAPHY: TIJMEN BALLIEUX



FORMANI®
TIMELESS

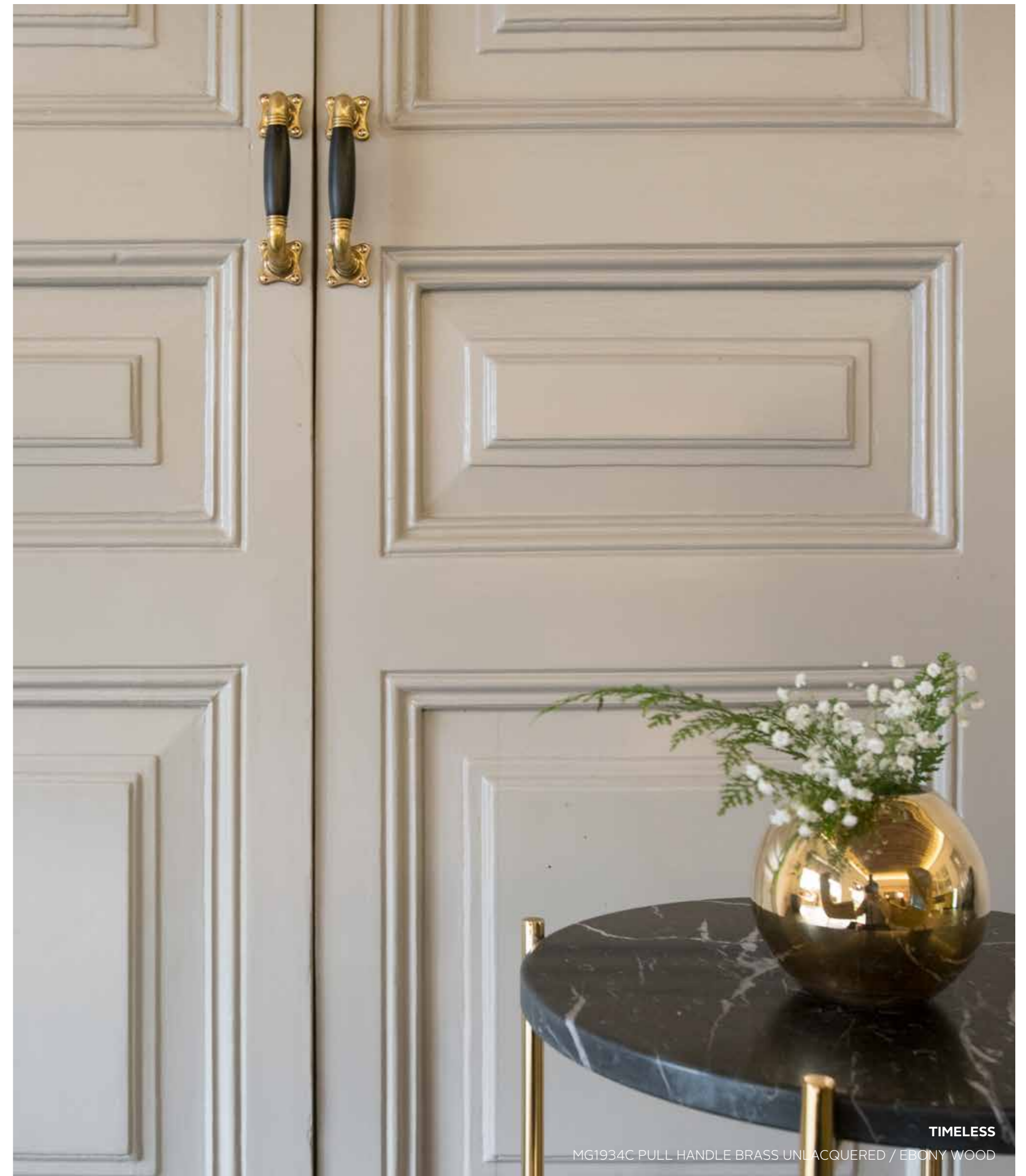

TIMELESS
MG1934C PULL HANDLE BRASS UNLACQUERED / EBONY WOOD



SPAIN'S MOST EXPENSIVE

Palau Malagrida is een stijlvol gebouw gelegen aan de statige Passeig de Gràcia. De avenue is meer dan een kilometer lang en de duurste van Spanje. Hier zijn enkele van de meest gevierde architectonische objecten van Barcelona gelegen. Palau Malagrida, vernoemd naar de familie die het gebouw in 1906 liet bouwen, mag zich tot die objecten rekenen.

Palau Malagrida is a stylish building located on the stately Passeig de Gràcia. This avenue stretches over more than one kilometre and is the most expensive street in Spain. It is also home to some of the most celebrated architectonic properties in Barcelona. Palau Malagrida, named after the family that commissioned the construction of the building in 1906, is one of these properties.

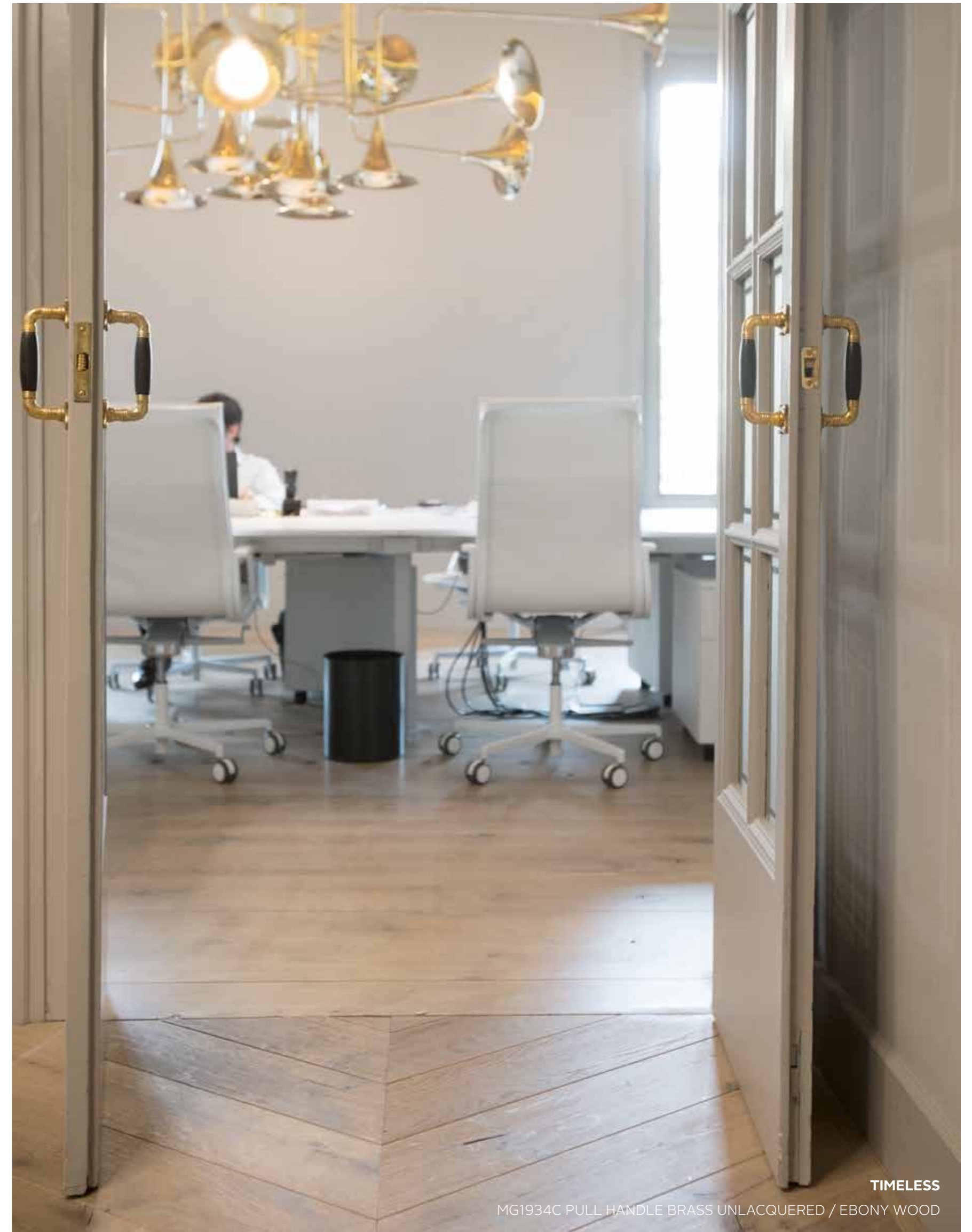

TIMELESS

MG1934C PULL HANDLE BRASS UNLACQUERED / EBONY WOOD



TIMELESS
MG1934C PULL HANDLE BRASS UNLACQUERED / EBONY WOOD



SPECTRUM OF MODERNISM

Palau Malagrida is een schoolvoorbeeld van modernisme. Met de bewoners door de jaren heen verloor het gebouw aanrijke, authentieke elementen. Bij de start van de reconstructie in 2014 werd de begane grond omgetoverd tot 500 m² vastgoed en designspectrum.

Bij de reconstructie van het gebouw stond het herstellen, behouden en verheffen van de artistieke en architectonische Catalaanse modernistische stijl centraal. Het ruimtelijk spel is daarbij een belangrijk element.

Palau Malagrida is a classic example of modernism. Over the years, the building lost many of its grand, authentic elements. At the start of reconstruction in 2014, the ground floor was transformed into a 500 m² property and design spectrum.

The focus of the reconstruction was the restoration, keeping, and enhancing of the artistic and architectonic Catalan modernist style. The spatial interplay is an important element in this.



TIMELESS
P-1934 ESPAGNOLETTE BOLT
BRASS UNLACQUERED / EBONY WOOD

EMPOWERING DOORWARE

Interieurarchitect Marta Casas koos voor dit project voor de elegantie van de Timeless-serie van FORMANI®. De esthetische vormgeving van de serie sluit aan bij de filosofie van het project om de architectonische herkomst naar de toekomst te verheffen.

For this project, interior designer Marta Casas, chose the elegance of the FORMANI® Timeless series. The aesthetic design of the series matches the philosophy of the project that focuses on bringing the architectonic provenance into the future.



TIMELESS
1934GRR50 LEVER HANDLE BRASS UNLACQUERED / EBONY WOOD

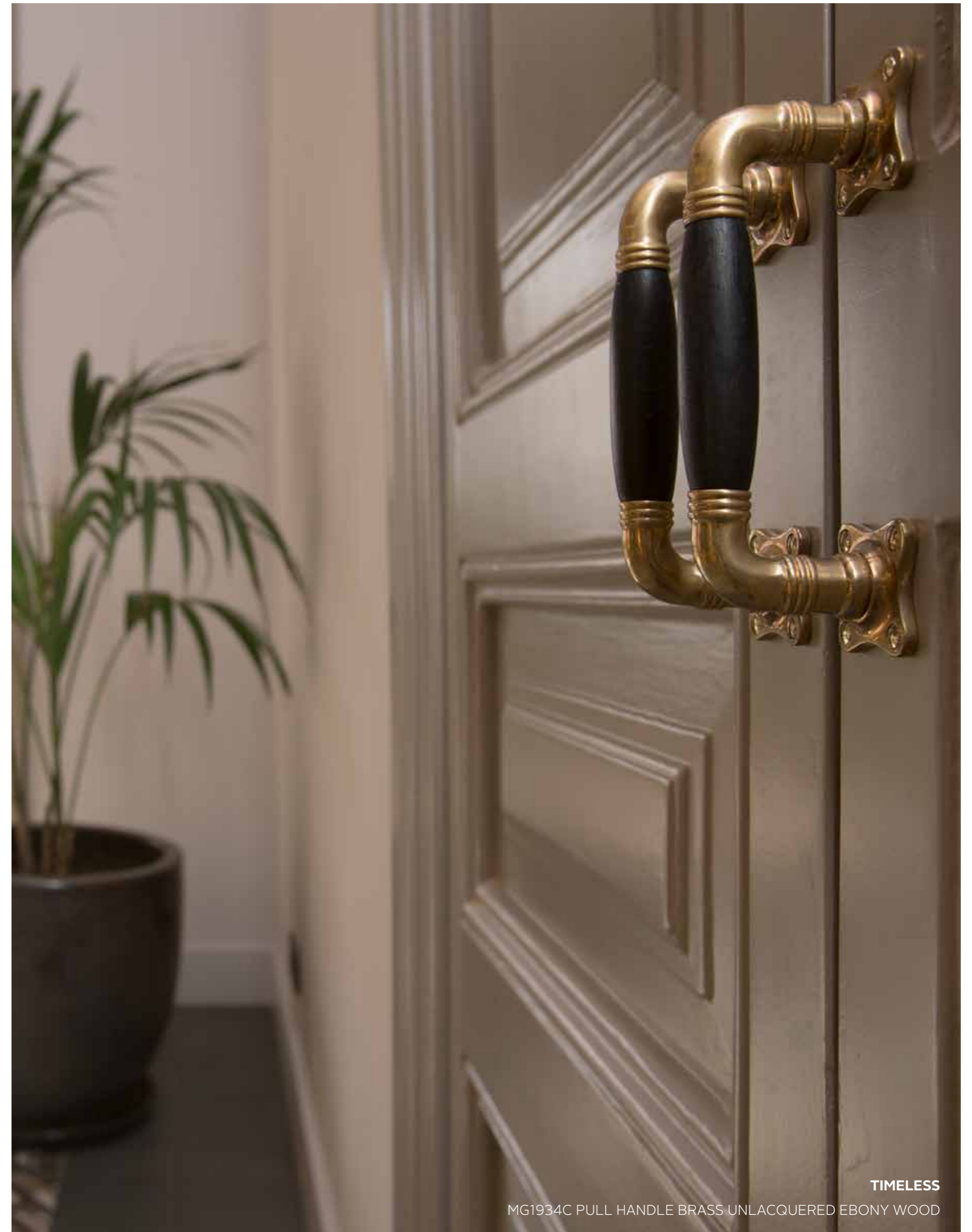

TIMELESS
MG1934C PULL HANDLE BRASS UNLACQUERED EBONY WOOD

FERROVIA

CHEMIN DE FER

De naam Ferrovia (vrij vertaald 'ijzeren weg') verwijst naar de spoorwegen. In het begin van de 20e eeuw werd dit type deurkruk namelijk veelal toegepast in de treinstellen in diverse West-Europese landen zoals België, Frankrijk en Italië. De meest bekende trein was wel de Orient Express waarvoor deze deurkrukken speciaal waren ontworpen. Met name het verticale T-krukje was erg in trek, destijds vaak in klein formaat.

In Frankrijk en delen van België is dit design ook wel beter bekend als 'Chemin de Fer'. De serie is gemoderniseerd en gefabriceerd uit massief roestvast staal (mat en gepolijst leverbaar) en gecompleteerd met de nodige accessoires, zoals diverse soorten raam- en meubelbeslag, waardoor alle functies binnen een huis (of ander object) met één en dezelfde stijl kunnen worden ingevuld.

The name Ferrovia (to be translated as 'iron road') refers to the railways. In the early twentieth century this particular style of door handle was often used in trains in European countries such as Belgium, France, and Italy. The most famous train of all was the Orient Express for which this door handle was specially designed. Especially the vertical 'T-Handle' was very popular in these trains.

In France and parts of Belgium this design is known as Chemin de Fer. Especially the vertical T-handle was used a lot, mostly in the smallest size. This series has been modernized and has been produced from solid stainless steel (available in matte and polished) and has been complemented with the necessary accessories including different types of window and furniture fittings which enables all functions within the home, or any other object, to be completed in one single style.



FORMANI STORIES

STORY PASADENA BAY, NIEUW ZEELAND STORY PASADENA BAY, NEW ZEALAND	458
STORY NEW YORK, VERENIGDE STATEN STORY NEW YORK, USA	486

DEURBESLAG | DOOR FITTINGS

DEURKRUKKEN LEVER HANDLES	468
ACCESSOIRES DEURKRUKKEN LEVER HANDLE ACCESSORIES	472

RAAMBESLAG | WINDOW FITTINGS

RAAMBOOMPJES CASEMENT FASTENERS	474
RAAMUITZETTERS CASEMENT STAYS	474
DRAAIKIEPBESLAG TILT AND TURN WINDOW HANDLES	474
KRUKESPAGNOLETTEN ESPAGNOLETTE BOLTS	477

VOORDEURBESLAG | FRONT DOOR FITTINGS

VOORDEURKNOPPEN FRONT DOOR KNOBS	479
GREPEN PULL HANDLES	479
VEILIGHEIDSCILINDERROZETTEN SECURITY ESCUTCHEONS	479
VEILIGHEIDSSCHILDEN SECURITY PLATES	479
BELDRUKKERS BELL PUSHES	481

ACCESSOIRES | ACCESSORIES

MEUBELGREPEN CABINET HANDLES	482
MEUBELKNOPPEN CABINET KNOBS	482
KNOPPEN KNOBS	483
GLASDEURKNOPPEN GLASS DOOR KNOBS	484
LUIKRINGEN FLUSH RINGS	484
HEFSCHUIFDEURBESLAG SLIDING DOOR HANDLES	484



NEW ZEALAND LAND PASADENA DENNA BAY

LOCATION: PASADENA BAY, NEW ZEALAND
OBJECT: PRIVATE RESIDENCE
ARCHITECTURE: CHRISTIAN ANDERSON ARCHITECTS
PHOTOGRAPHY: SIMON DEVITT

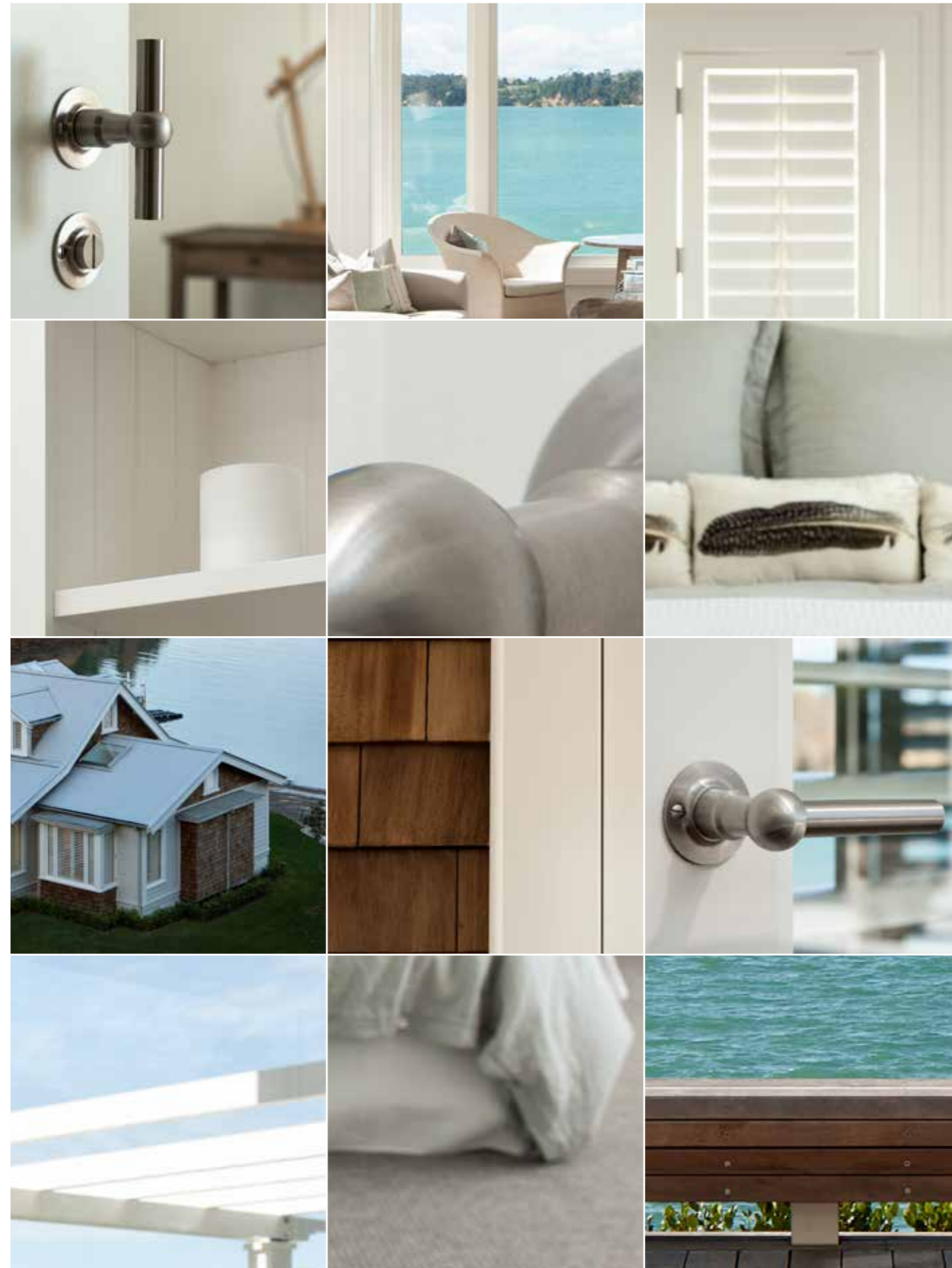

FORMANI®
FERROVIA



FERROVIA
FVT125/52 LEVER HANDLE SATIN STAINLESS STEEL



COLONIAL RESIDENCES

In Pasadena Bay staan enkele prachtige houten vakantiehuisjes die het gevoel geven alsof de tijd heeft stilgestaan. De cluster van huisjes doet denken aan de vroeg-koloniale nederzettingen aan de Nieuw Zeelandse kust.

De iconische spitse boog doorbreekt het weidse uitzicht en kijkt uit over een fantastisch landschap, dat als het ware wordt omlijst door de boog. De overdekte veranda en het terras gaan naadloos op in de natuurlijke omgeving en de meubels kunnen worden verschoven zodat bezoekers in de zon en toch beschermt kunnen zitten.

Pasadena Bay loges a series of finely crafted timber cottages that provide holiday residence with a relaxed pace reminiscent of an earlier time. The cottages are grouped in a village cluster common with early colonial habitation of coastal settlements on the New Zealand coast.

The iconic, gabled arch forms are extruded through the view axis to provide a range of habitation. They allow integration with the natural environment through the utilisation of protected porches and terraces, and flexible joinery arrangements to orientate to the sun or provide a range of shelter.



FERROVIA

FVL125/52 LEVER HANDLE SATIN STAINL. STEEL



THAT MARITIME FEELING

De combinatie van behandeld architecturaal metaal, decoratieve verlichting en hardware in een subtiele maritieme stijl past perfect bij de handvervaardigde vormen en versterkt het lokale gevoel. Deze eigentijdse interpretatie van een historische woning van de hand van ontwerper Christian Anderson versterkt de bijzondere charme en het karakter van Pasadena Bay.

The combination of worked architectural metal work, with decorative lighting and hardware in a subtle maritime style complement the crafted forms and reinforce the vernacular response. This contemporary interpretation from designer Christian Anderson of a historic habitation enhances a special charm and character of Pasadena Bay.



FERROVIA
FVT125/52 LEVER HANDLE SATIN STAINLESS STEEL
FVWC48 PRIVACY SET SATIN STAINLESS STEEL



SUBTILE FINISH

Ontwerper Christian Anderson koos voor de Ferrovía-collectie vanwege haar tijdloze en klassieke stijl. Deze stijl draagt bij aan het kustgevoel van de huisjes, iets wat bovendien verder wordt versterkt door de subtiele lijnen van de geborsteld roestvast stalen afwerking.

Designer Christian Anderson chose the Ferrovía series because of its timeless and classic style. A style that complements the coastal feel of the property enhanced with the subtle lines of the selected brushed stainless steel finish.



FERROVIA
FVL125/52 LEVER HANDLE SATIN STAINLESS STEEL

FVL85/40

massieve deurkruk vast-draaibaar
ongeveer op rozet
op aanvraag ook op schild leverbaar

solid unsprung lever handle
attached to rose
also available on plate, on request

mat roestvast staal
satin stainless steel

gepolijst roestvast staal
polished stainless steel

FVT85/40

massieve deurkruk vast-draaibaar
ongeveer op rozet
ideale doormaat slot 60mm
op aanvraag ook op schild leverbaar

solid unsprung lever handle
attached to rose
ideal lock backset 60mm
also available on plate, on request

mat roestvast staal
satin stainless steel

gepolijst roestvast staal
polished stainless steel

FVL100/48

massieve deurkruk vast-draaibaar
ongeveer op rozet
op aanvraag ook op schild leverbaar

solid unsprung lever handle
attached to rose
also available on plate, on request

mat roestvast staal
satin stainless steel

gepolijst roestvast staal
polished stainless steel

FVT100/48

massieve deurkruk vast-draaibaar
ongeveer op rozet
ideale doormaat slot 60mm
op aanvraag ook op schild leverbaar

solid unsprung lever handle
attached to rose
ideal lock backset 60mm
also available on plate, on request

mat roestvast staal
satin stainless steel

gepolijst roestvast staal
polished stainless steel

FVL110/52

massieve deurkruk vast-draaibaar
ongeveer op rozet

solid unsprung lever handle
attached to rose

mat roestvast staal
satin stainless steel

gepolijst roestvast staal
polished stainless steel

FVL110P236

massieve deurkruk vast-draaibaar
ongeveer op schild, een zijde met
en een zijde zonder zichtbare bevestiging

solid unsprung lever handle
attached to plate
fixings visible on one side only

mat roestvast staal
satin stainless steel

gepolijst roestvast staal
polished stainless steel

* afstand opgeven bij bestelling
* state distance on order

FVT110/52

massieve deurkruk vast-draaibaar
ongeveer op rozet
ideale doormaat slot 60mm

solid unsprung lever handle
attached to rose
ideal lock backset 60mm

mat roestvast staal
satin stainless steel

gepolijst roestvast staal
polished stainless steel

FVT110P236

massieve deurkruk vast-draaibaar
ongeveer op schild, een zijde met
en een zijde zonder zichtbare bevestiging
ideale doormaat slot 60mm

solid unsprung lever handle
attached to plate
fixings visible on one side only
ideal lock backset 60mm

mat roestvast staal
satin stainless steel

gepolijst roestvast staal
polished stainless steel

* afstand opgeven bij bestelling
* state distance on order

FVL125/52

massieve deurkruk vast-draaibaar
ongeveer op rozet

solid unsprung lever handle
attached to rose

mat roestvast staal
satin stainless steel

gepolijst roestvast staal
polished stainless steel

FVL125P236

massieve deurkruk vast-draaibaar
ongeveer op schild, een zijde met
en een zijde zonder zichtbare bevestiging

solid unsprung lever handle
attached to plate
fixings visible on one side only

mat roestvast staal
satin stainless steel

gepolijst roestvast staal
polished stainless steel

* afstand opgeven bij bestelling
* state distance on order

FVT125/52

massieve deurkruk vast-draaibaar
ongeveer op rozet
ideale doormaat slot 60mm

solid unsprung lever handle
attached to rose
ideal lock backset 60mm

mat roestvast staal
satin stainless steel

gepolijst roestvast staal
polished stainless steel

FVT125P236

massieve deurkruk vast-draaibaar
ongeveer op schild, een zijde met
en een zijde zonder zichtbare bevestiging
ideale doormaat slot 60mm



solid unsprung lever handle
attached to plate
fixings visible on one side only
ideal lock backset 60mm

mat roestvast staal
satin stainless steel

gepolijst roestvast staal
polished stainless steel

* afstand opgeven bij bestelling
* state distance on order



FVBN40 sleutelplaatje | key escutcheon

FVBN40

mat roestvast staal | satin stainless steel
gepolijst roestvast staal | polished stainless steel

FVBN48 sleutelplaatje | key escutcheon

FVBN48

mat roestvast staal | satin stainless steel
gepolijst roestvast staal | polished stainless steel

FVBY40 cilinderplaatje | profile cylinder escutcheon

FVBY40

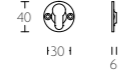
mat roestvast staal | satin stainless steel
gepolijst roestvast staal | polished stainless steel

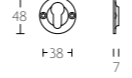

FVBY48 cilinderplaatje | profile cylinder escutcheon

FVBY48

mat roestvast staal | satin stainless steel
gepolijst roestvast staal | polished stainless steel



FVB40 blind plaatje | blank escutcheon

FVB40

mat roestvast staal | satin stainless steel
gepolijst roestvast staal | polished stainless steel

FVB48 blind plaatje | blank escutcheon

FVB48

mat roestvast staal | satin stainless steel
gepolijst roestvast staal | polished stainless steel

FVWC40 toiletgarnituur | turn and release set



FVWC40

mat roestvast staal | satin stainless steel
gepolijst roestvast staal | polished stainless steel

FVWC48 toiletgarnituur | turn and release set





FVWC48

mat roestvast staal | satin stainless steel
gepolijst roestvast staal | polished stainless steel

LBR50EN EN1906 klasse 4 rozet enkel geveerd, combineren met deurkruk naar keuze | EN1906 class 4 rose single spring to be combined with door handle of choice

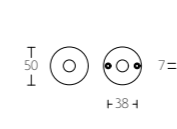
4 7 - B 0 4 0 B

LBR50EN

mat roestvast staal | satin stainless steel
gepolijst roestvast staal | polished stainless steel

LSQR32G smalrozet dubbel geveerd t.b.v. aluminium of stalen deuren, combineren met deurkruk naar keuze | narrow rose with double spring to be combined with door handle of choice

LSQR32G LSQBN32 LSQBY32

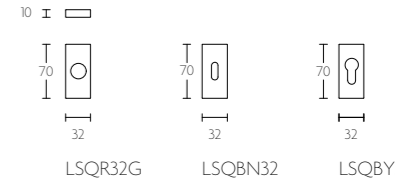
mat roestvast staal | satin stainless steel
gepolijst roestvast staal | polished stainless steel

LBR53 kliikrozet enkel geveerd combineren met deurkruk naar keuze | concealed rose with single spring to be combined with door handle of choice





LBR53

mat roestvast staal | satin stainless steel
gepolijst roestvast staal | polished stainless steel

FV-RB

massief raamboompje ten behoeve van naar buitendraaiend raam inclusief contraplaatje niet afsluitbaar

non-locking solid casement fastener for outward opening window including mortice plate



mat roestvast staal
satin stainless steel

gepolijst roestvast staal
polished stainless steel

HP-RB

losse haak ten behoeve van raamboompje voor naar binnendraaiend raam

separate hook plate for casement fastener for inward opening window



mat roestvast staal
satin stainless steel

gepolijst roestvast staal
polished stainless steel

FV305

massieve raamuitzetter met twee stelpennen inclusief geleiderail

solid casement stay with two pins including slide guide channel

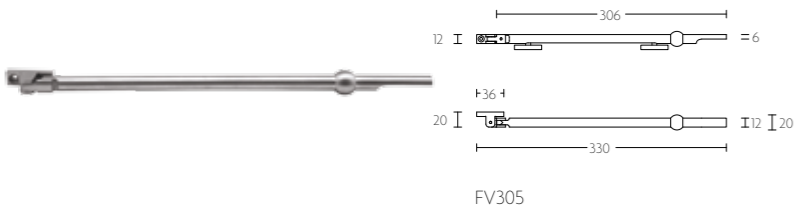

mat roestvast staal
satin stainless steel

gepolijst roestvast staal
polished stainless steel

FVL85-DK

draaikiepgarnituur niet afsluitbaar op aanvraag ook op ovale rozet leverbaar

non-locking tilt and turn window handle also available on oval rose, on request



mat roestvast staal
satin stainless steel

gepolijst roestvast staal
polished stainless steel

FVT85-DK

draaikiepgarnituur niet afsluitbaar op aanvraag ook op ovale rozet leverbaar

non-locking tilt and turn window handle also available on oval rose, on request



mat roestvast staal
satin stainless steel

gepolijst roestvast staal
polished stainless steel

FVL100-DK

draaikiepgarnituur niet afsluitbaar op aanvraag ook op ovale rozet leverbaar

non-locking tilt and turn window handle also available on oval rose, on request



mat roestvast staal
satin stainless steel

gepolijst roestvast staal
polished stainless steel

FVT100-DK

draaikiepgarnituur niet afsluitbaar op aanvraag ook op ovale rozet leverbaar

non-locking tilt and turn window handle also available on oval rose, on request



mat roestvast staal
satin stainless steel

gepolijst roestvast staal
polished stainless steel

FVL110-DK

draaikiepgarnituur niet afsluitbaar op aanvraag ook op ovale rozet leverbaar

non-locking tilt and turn window handle also available on oval rose, on request



mat roestvast staal
satin stainless steel

gepolijst roestvast staal
polished stainless steel

FVT110-DK

draaikiepgarnituur niet afsluitbaar op aanvraag ook op ovale rozet leverbaar

non-locking tilt and turn window handle also available on oval rose, on request



mat roestvast staal
satin stainless steel

gepolijst roestvast staal
polished stainless steel

FVL125-DK

draaikiepgarnituur niet afsluitbaar op aanvraag ook op ovale rozet leverbaar

non-locking tilt and turn window handle also available on oval rose, on request



mat roestvast staal
satin stainless steel

gepolijst roestvast staal
polished stainless steel

FVT125-DK

draaikiepgarnituur niet afsluitbaar op aanvraag ook op ovale rozet leverbaar

non-locking tilt and turn window handle also available on oval rose, on request



mat roestvast staal
satin stainless steel

gepolijst roestvast staal
polished stainless steel

FVL85-DKLOCK

draaikiepgarnituur afsluitbaar op aanvraag ook op afgeronde rozet leverbaar

locking tilt and turn window handle also available on rounded rose, on request



mat roestvast staal
satin stainless steel

gepolijst roestvast staal
polished stainless steel

FVT85-DKLOCK

draaiepgarnituur afsluitbaar op aanvraag ook op afgeronde rozet leverbaar

locking tilt and turn window handle also available on rounded rose, on request



mat roestvast staal satin stainless steel

gepolijst roestvast staal polished stainless steel

FVL100-DKLOCK

draaiepgarnituur afsluitbaar op aanvraag ook op afgeronde rozet leverbaar

locking tilt and turn window handle also available on rounded rose, on request



mat roestvast staal satin stainless steel

gepolijst roestvast staal polished stainless steel

FVT125-DKLOCK

draaiepgarnituur afsluitbaar op aanvraag ook op afgeronde rozet leverbaar

locking tilt and turn window handle also available on rounded rose, on request



mat roestvast staal satin stainless steel

gepolijst roestvast staal polished stainless steel

K-FVL85

krukespagolet inclusief vier geleiders, twee eindstukjes en twee stangen standaard geschikt tot 2900mm op aanvraag ook op ovaal mechsime leverbaar

espagnolette bolt with top and bottom receiver plate, two rods and four rod guides standard to suit 2900mm also available on oval base plate, on request



mat roestvast staal satin stainless steel

gepolijst roestvast staal polished stainless steel

FVT100-DKLOCK

draaiepgarnituur afsluitbaar op aanvraag ook op afgeronde rozet leverbaar

locking tilt and turn window handle also available on rounded rose, on request



mat roestvast staal satin stainless steel

gepolijst roestvast staal polished stainless steel

FVL110-DKLOCK

draaiepgarnituur afsluitbaar op aanvraag ook op afgeronde rozet leverbaar

locking tilt and turn window handle also available on rounded rose, on request



mat roestvast staal satin stainless steel

gepolijst roestvast staal polished stainless steel

K-FVT85

krukespagolet inclusief vier geleiders, twee eindstukjes en twee stangen standaard geschikt tot 2900mm op aanvraag ook op ovaal mechsime leverbaar

espagnolette bolt with top and bottom receiver plate, two rods and four rod guides standard to suit 2900mm also available on oval base plate, on request

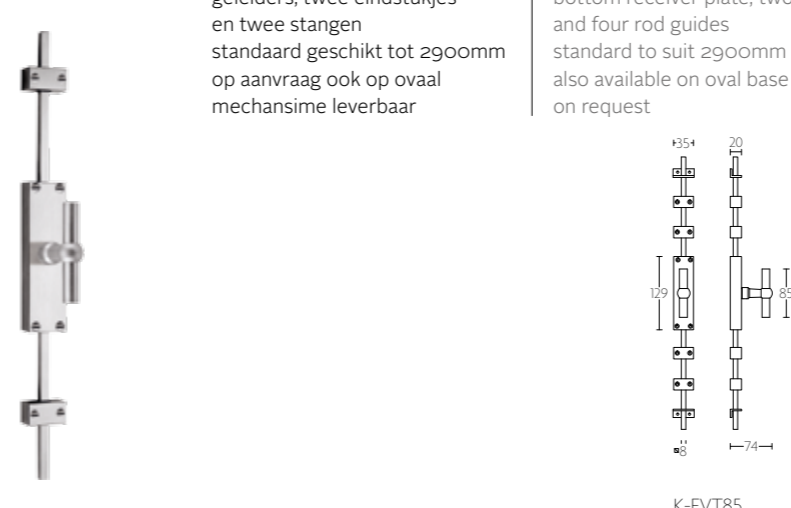

mat roestvast staal satin stainless steel

gepolijst roestvast staal polished stainless steel

K-FVL100

krukespagolet inclusief vier geleiders, twee eindstukjes en twee stangen standaard geschikt tot 2900mm op aanvraag ook op ovaal mechsime leverbaar

espagnolette bolt with top and bottom receiver plate, two rods and four rod guides standard to suit 2900mm also available on oval base plate, on request



mat roestvast staal satin stainless steel

gepolijst roestvast staal polished stainless steel

FVT110-DKLOCK

draaiepgarnituur afsluitbaar op aanvraag ook op afgeronde rozet leverbaar

locking tilt and turn window handle also available on rounded rose, on request



mat roestvast staal satin stainless steel

gepolijst roestvast staal polished stainless steel

FVL125-DKLOCK

draaiepgarnituur afsluitbaar op aanvraag ook op afgeronde rozet leverbaar

locking tilt and turn window handle also available on rounded rose, on request



mat roestvast staal satin stainless steel

gepolijst roestvast staal polished stainless steel

K-FVT100

krukespagolet inclusief vier geleiders, twee eindstukjes en twee stangen standaard geschikt tot 2900mm op aanvraag ook op ovaal mechsime leverbaar

espagnolette bolt with top and bottom receiver plate, two rods and four rod guides standard to suit 2900mm also available on oval base plate, on request

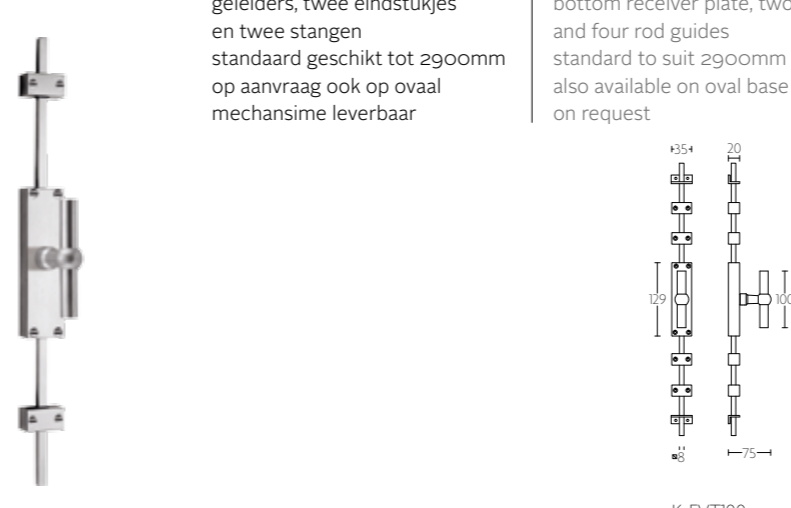

mat roestvast staal satin stainless steel

gepolijst roestvast staal polished stainless steel

K-FVL110

krukespagolet inclusief vier geleiders, twee eindstukjes en twee stangen standaard geschikt tot 2900mm op aanvraag ook op ovaal mechsime leverbaar

espagnolette bolt with top and bottom receiver plate, two rods and four rod guides standard to suit 2900mm also available on oval base plate, on request



mat roestvast staal satin stainless steel

gepolijst roestvast staal polished stainless steel

K-FVT110

krukespagolet inclusief vier geleiders, twee eindstukjes en twee stangen standaard geschikt tot 2900mm op aanvraag ook op ovaal mechsime leverbaar

espagnolette bolt with top and bottom receiver plate, two rods and four rod guides standard to suit 2900mm also available on oval base plate, on request

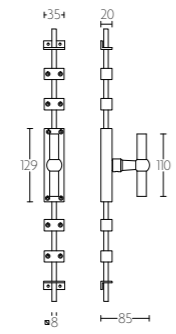

K-FVT110

mat roestvast staal satin stainless steel
gepolijst roestvast staal polished stainless steel

K-FVL125

krukespagolet inclusief vier geleiders, twee eindstukjes en twee stangen standaard geschikt tot 2900mm op aanvraag ook op ovaal mechsime leverbaar

espagnolette bolt with top and bottom receiver plate, two rods and four rod guides standard to suit 2900mm also available on oval base plate, on request

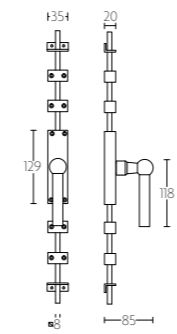

K-FVL125

mat roestvast staal satin stainless steel
gepolijst roestvast staal polished stainless steel

K-FVT125

krukespagolet inclusief vier geleiders, twee eindstukjes en twee stangen standaard geschikt tot 2900mm op aanvraag ook op ovaal mechsime leverbaar

espagnolette bolt with top and bottom receiver plate, two rods and four rod guides standard to suit 2900mm also available on oval base plate, on request

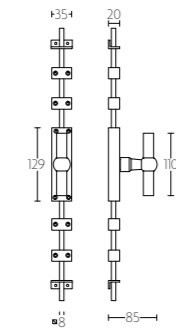

K-FVT125

mat roestvast staal satin stainless steel
gepolijst roestvast staal polished stainless steel

E-LOCK8

slot ten behoeve van espagnoletstang 8mm lock for espagnolette rod 8mm

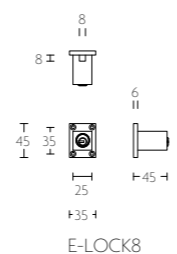

E-LOCK8

mat roestvast staal satin stainless steel
gepolijst roestvast staal polished stainless steel

FV22V

massieve voordeurknop vast op rozet solid front door knob fixed on rose

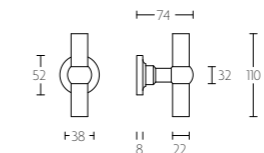

FV22V

mat roestvast staal satin stainless steel
gepolijst roestvast staal polished stainless steel

FV22D

massieve draaibare voordeurknop vast-draaibaar op rozet, ongeveerd solid unsprung front door knob to operate, attached to rose

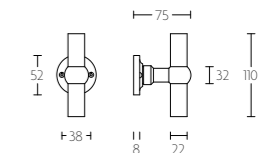

FV22D

mat roestvast staal satin stainless steel
gepolijst roestvast staal polished stainless steel

PB220

by Piet Boon

massieve knop vast op rozet solid knob fixed on rose

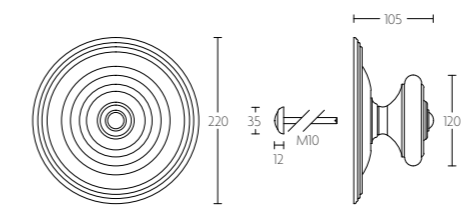

PB220

messing verzilverd silver unacquered
mat roestvast staal satin stainless steel
gepolijst roestvast staal polished stainless steel

FV360

massieve greep tbv houten, glazen of aluminium deuren doorgaande, niet-doorgaande of paarsgewijze bevestiging

solid pull handle for timber, glass or aluminium doors bolt through, concealed or back to back fixings

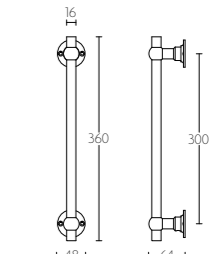

FV360

mat roestvast staal satin stainless steel
gepolijst roestvast staal polished stainless steel

FV-VEIL

massieve veiligheidscilinderrozet solid security escutcheons

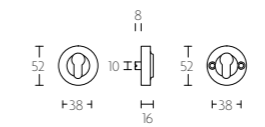

FV-VEIL

mat roestvast staal satin stainless steel
gepolijst roestvast staal polished stainless steel

FV22-50

massieve veiligheidsschilden met vaste knop, ten behoeve van deurkruk solid security plates with fixed knob to suit lever handle

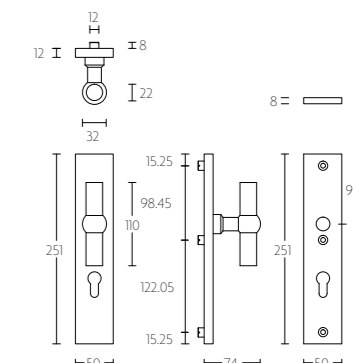
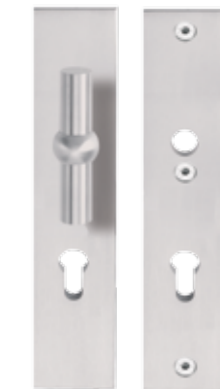

FV22-50

* afstand opgeven bij bestelling * state distance on order

mat roestvast staal satin stainless steel
gepolijst roestvast staal polished stainless steel

FV22-50KT massieve veiligheidsschilden met vaste knop, ten behoeve van deurkruk met kerntrekbeveiliging | solid security plates with fixed knob to suit lever handle with cylinder protection cover

mat roestvast staal | gepolijst roestvast staal
satin stainless steel | polished stainless steel

FV22-50KT * afstand opgeven bij bestelling * state distance on order

LSQSM-50 massieve veiligheidsschilden ten behoeve van deurkrukken | solid security plates to suit lever handles

mat roestvast staal | gepolijst roestvast staal
satin stainless steel | polished stainless steel

LSQSM-50 * afstand opgeven bij bestelling * state distance on order

LSQSM-28KT massieve veiligheidsschilden ten behoeve van deurkrukken met kerntrekbeveiliging | solid security plates to suit lever handles with cylinder protection cover

mat roestvast staal | gepolijst roestvast staal
satin stainless steel | polished stainless steel

LSQSM-28KT * afstand opgeven bij bestelling * state distance on order

FV48 beldrukker met roestvast stalen drukertje | bell push with stainless steel bell button

mat roestvast staal | gepolijst roestvast staal
satin stainless steel | polished stainless steel

FV48

LSQSM-50KT massieve veiligheidsschilden ten behoeve van deurkrukken met kerntrekbeveiliging | solid security plates to suit lever handles with cylinder protection cover

mat roestvast staal | gepolijst roestvast staal
satin stainless steel | polished stainless steel

LSQSM-50KT * afstand opgeven bij bestelling * state distance on order

FV22-28 massieve veiligheidsschilden met vaste knop, ten behoeve van deurkruk | solid security plates with fixed knob to suit lever handle

mat roestvast staal | gepolijst roestvast staal
satin stainless steel | polished stainless steel

FV22-28 * afstand opgeven bij bestelling * state distance on order

FV22-28KT massieve veiligheidsschilden met vaste knop, ten behoeve van deurkruk met kerntrekbeveiliging | solid security plates with fixed knob to suit lever handle with cylinder protection cover

mat roestvast staal | gepolijst roestvast staal
satin stainless steel | polished stainless steel

FV22-28KT * afstand opgeven bij bestelling * state distance on order

LSQSM-28 massieve veiligheidsschilden ten behoeve van deurkrukken | solid security plates to suit lever handles

mat roestvast staal | gepolijst roestvast staal
satin stainless steel | polished stainless steel

LSQSM-28 * afstand opgeven bij bestelling * state distance on order

FV195/96 massieve meubelgreep | solid cabinet handle

mat roestvast staal
satin stainless steel

gepolijst roestvast staal
polished stainless steel

FV195/128 massieve meubelgreep | solid cabinet handle

mat roestvast staal
satin stainless steel

gepolijst roestvast staal
polished stainless steel

FV195/160 massieve meubelgreep | solid cabinet handle

mat roestvast staal
satin stainless steel

gepolijst roestvast staal
polished stainless steel

FV195/192 massieve meubelgreep | solid cabinet handle

mat roestvast staal
satin stainless steel

gepolijst roestvast staal
polished stainless steel

FV195/224 massieve meubelgreep | solid cabinet handle

mat roestvast staal
satin stainless steel

gepolijst roestvast staal
polished stainless steel

FV190 massieve meubelknop | solid cabinet knob

mat roestvast staal
satin stainless steel

gepolijst roestvast staal
polished stainless steel

FV195 massieve meubelknop | solid cabinet knob

mat roestvast staal
satin stainless steel

gepolijst roestvast staal
polished stainless steel

FVT85V/40 massieve knop vast op rozet | solid knob fixed on rose

mat roestvast staal
satin stainless steel

gepolijst roestvast staal
polished stainless steel

FVT85VP236 massieve knop vast op schild | solid knob fixed on plate

mat roestvast staal
satin stainless steel

gepolijst roestvast staal
polished stainless steel

* afstand opgeven bij bestelling
* state distance on order

FVT100V/48 massieve knop vast op rozet | solid knob fixed on rose

mat roestvast staal
satin stainless steel

gepolijst roestvast staal
polished stainless steel

FVT100VP236 massieve knop vast op schild | solid knob fixed on plate

mat roestvast staal
satin stainless steel

gepolijst roestvast staal
polished stainless steel

* afstand opgeven bij bestelling
* state distance on order

FVT110V/52 massieve knop vast op rozet | solid knob fixed on rose

mat roestvast staal
satin stainless steel

gepolijst roestvast staal
polished stainless steel

FVT110VP236 massieve knop vast op schild | solid knob fixed on plate

FVT110VP236SFC FVT110VP236N* FVT110VP236Y*

* afstand opgeven bij bestelling
* state distance on order

mat roestvast staal | satin stainless steel
gepolijst roestvast staal | polished stainless steel

FVT125V/52 massieve knop vast op rozet | solid knob fixed on rose

FVT125V/52

mat roestvast staal | satin stainless steel
gepolijst roestvast staal | polished stainless steel

FV230PA massieve paarsgewijze set hefschuifdeurbeslag op aanvraag ook op ovaal mechanisme leverbaar | pair of solid lift-up sliding door handles also available on oval base plate, on request

FV230PA

* blind of PC69
* blind or Y69

mat roestvast staal | satin stainless steel
gepolijst roestvast staal | polished stainless steel

FVT125VP236 massieve knop vast op schild | solid knob fixed on plate

FVT125VP236SFC FVT125VP236N* FVT125VP236Y*

* afstand opgeven bij bestelling
* state distance on order

mat roestvast staal | satin stainless steel
gepolijst roestvast staal | polished stainless steel

FV22G set massieve glasdeurknoppen vast op rozet | set of solid knobs for glass door fixed on rose

FV22G

mat roestvast staal | satin stainless steel
gepolijst roestvast staal | polished stainless steel

FV38 luikring | flush ring

FV38

mat roestvast staal | satin stainless steel
gepolijst roestvast staal | polished stainless steel

FV230 massieve set hefschuifdeurbeslag inclusief schuifdeurkom voor buitenzijde op aanvraag ook op ovaal mechanisme leverbaar | single solid internal lift-up sliding door handle with external flush pull also available on oval base plate, on request

FV230

* blind of PC69
* blind or Y69

mat roestvast staal | satin stainless steel
gepolijst roestvast staal | polished stainless steel

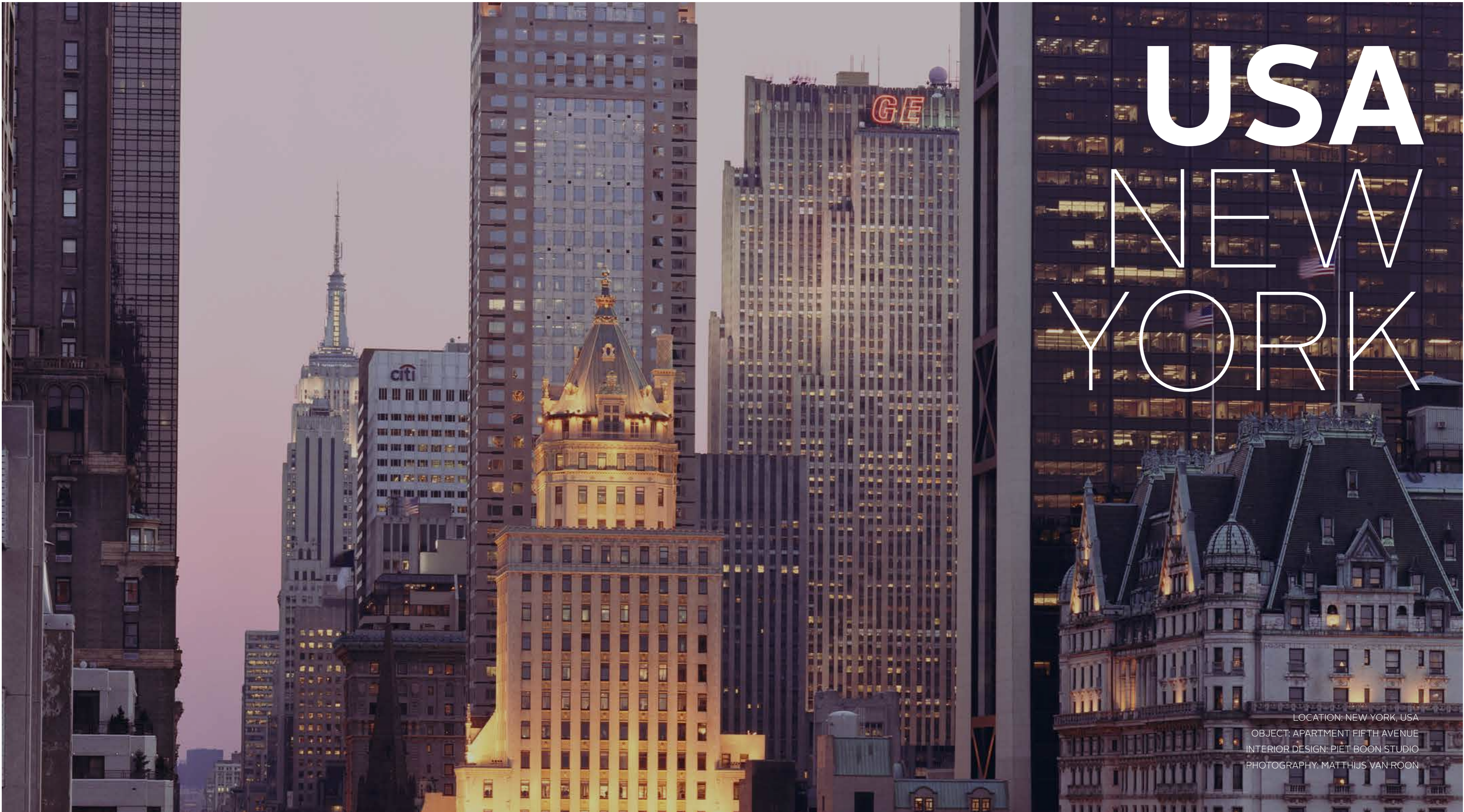

USA NEW YORK

LOCATION: NEW YORK, USA
OBJECT: APARTMENT FIFTH AVENUE
INTERIOR DESIGN: PIET BOON STUDIO
PHOTOGRAPHY: MATTHIJS VAN ROON

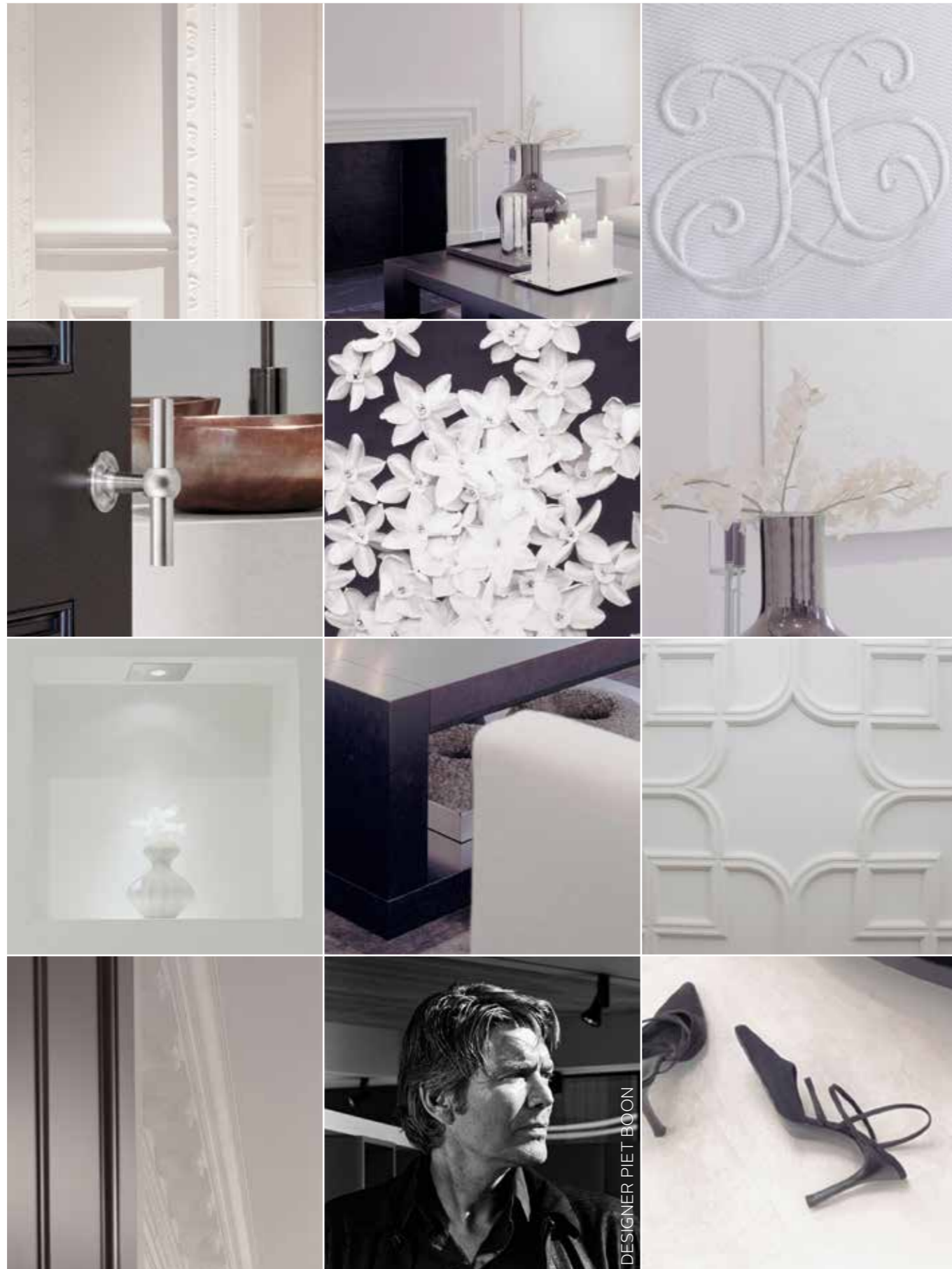

FORMANI®
FERROVIA

DESIGNER PIET BOON



FERROVIA
PB220 POLISHED STAINLESS STEEL



DESIGN DOORWARE

Bij deze exclusieve topwoning stond het creëren van een balans tussen de verschillende ruimtes en het optimaal benutten van natuurlijk licht centraal, met name in de woonruimtes die uitkijken op Central Park. Het resultaat is een rijke, internationale stijl met elementen van Europees design mede dankzij FORMANI®-details uit de Ferrovia collectie.

De opvallende ronde deurknoppen van de voordeuren zijn ontworpen door Piet Boon. De deuren lijken haast rond deze kunstwerken te zijn ontworpen. Het subtiele gebruik van details en kleur maken dit appartement aan Fifth Avenue tot een oase van verfijnde rust met een haast meditatieve, zen-achtige sfeer.

This exquisite residence is all about balance between the various rooms and making optimal use of the natural light, especially in the living spaces overlooking Central Park. The result is a rich, international style, with elements of European design with FORMANI® details from the Ferrovia series.

The striking, round doorknobs of the main doors are designed by Piet Boon. The doors almost seem to be designed around those pieces of art. The subtle use of details and color make this apartment on Fifth Avenue an oasis of refined tranquility, exuding an almost meditative, Zen-like atmosphere.

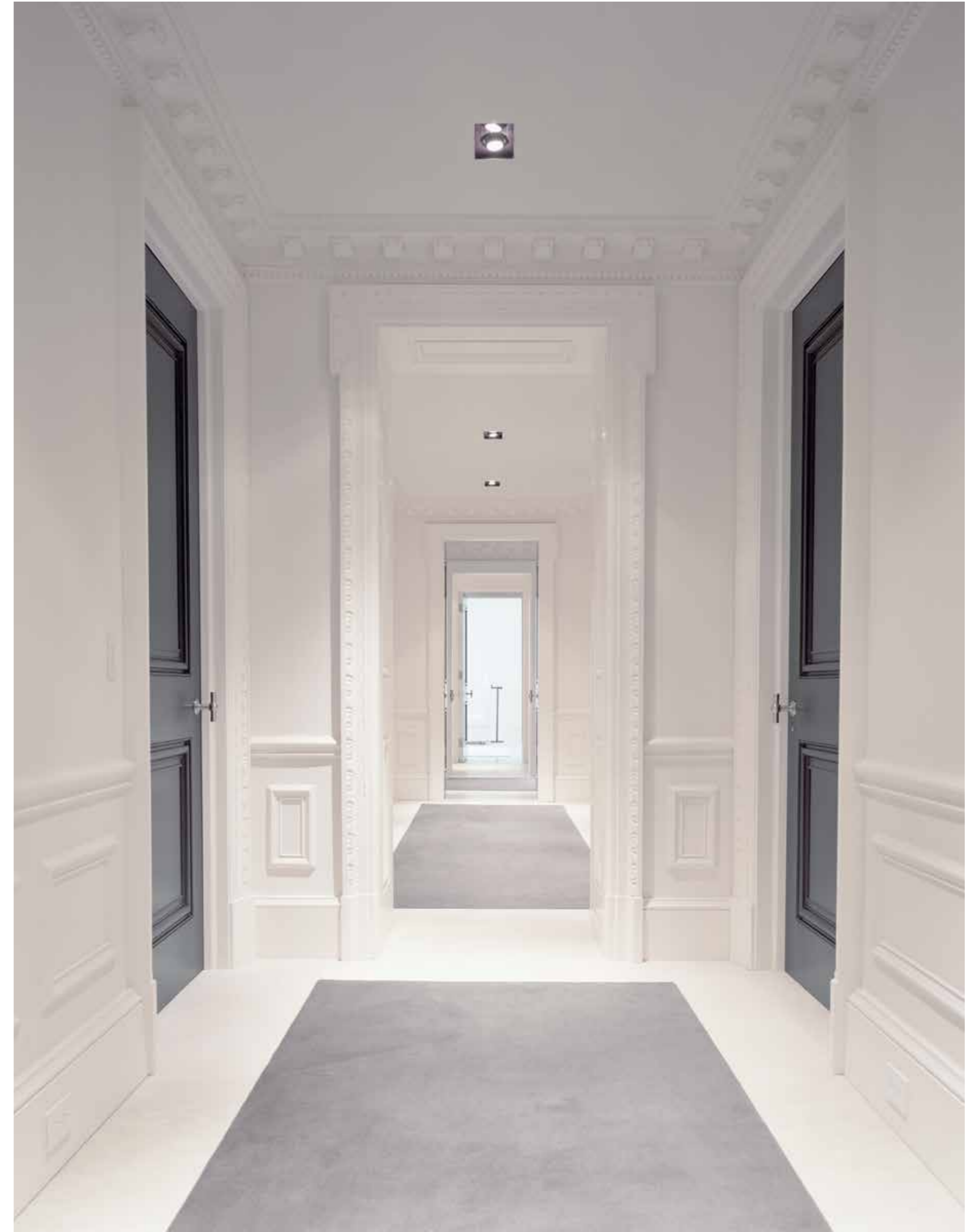



FERROVIA
FVT110/52 LEVER HANDLE POLISHED STAINLESS STEEL

TRAVELWARE

Het deurbeslag uit de Ferrovia-collectie, dat ook is gebruikt voor de deuren in de hal, is een eerbetoon aan het verleden. Ferrovia is Italiaans voor spoorweg. Dit design verwijst naar de deurkrukken die begin 20e eeuw veelal werden toegepast in treinstellen in heel Europa en verleent het appartement mede zijn internationale karakter.

The doorware from the Ferrovia serie, repeatedly used for the doors in the hallway, is a tribute to the past. Ferrovia means railway. The design buys into the doorware that was used in trains all over Europe at the beginning of Twentieth century and adds to the international style of the apartment.

